

DH-IPC-HDW5842TM-ASE

8MP IR Fixed-focal Eyeball WizMind Network Camera



Launched by Dahua Technology, Dahua WizMind is a full portfolio of solutions composed of project-oriented products including IPC, IVSS, NVR, PTZ, XVR, Thermal and software platform which adopts industry-leading deep learning algorithms. Focusing on customer's requirements, WizMind provides precise, reliable and comprehensive AI solutions for verticals.

Series Overview

Driven by deep learning algorithms, Dahua WizMind S Series network camera offers a variety of intelligent functions that greatly improve the accuracy of audio and video analysis. It supports video metadata, smart sound detection, face detection, perimeter protection, people counting and more. The camera also adopts advanced image processing AI-Powered Image technology and has the DeepLight night vision effect. The camera is dustproof, waterproof and vandal-proof, and is certified as IP67 and IK10 (the type of protection varies depending on the model).

Functions

AI-Powered Image

With AI ISP technology, the camera is able to easily adapt to scenes, producing high quality images that reveal the fine details of targets.

Perimeter Protection

With deep learning algorithm, Dahua Perimeter Protection technology can recognize human and vehicle accurately. In restricted area (such as pedestrian area and vehicle area), the false alarms of intelligent detection based on target type (such as tripwire, intrusion, fast moving, parking detection, loitering detection and gathering detection) are largely reduced.

Face Detection

Dahua Face Detection technology can detect the face in the image. With deep learning algorithm, the technology supports detecting, tracking, capturing and selecting the best face image, and then outputs face snapshot.

Smart Sound Detection

With deep learning algorithms, Dahua Smart Sound Detection technology can detect and identify the sound of screams, glass breaking, and more.

*** The parameters and datasheets below can only be applied to 5842-ASE-S3 series.**

- 8-MP 1/1.8" CMOS image sensor, low luminance, and high definition image.
- Outputs max. 8 MP (3840×2160) @25/30fps.
- Built-in IR LED, and the max. illumination distance is 50 m.
- ROI, SVC, SMART H.264+/H.265+, AI H.264/H.265, encoding after filter, flexible coding, applicable to various bandwidth and storage environments.
- Rotation mode, WDR, 3D NR, HLC, BLC, digital watermarking, applicable to various monitoring scenes.
- With deep learning algorithm, it supports: video metadata, smart sound detection, IVS, face detection, smart object detection, and people counting, etc.
- Alarm: 1 in, 1 out; audio: 1 in, 1 out; supports max. 512 GB Micro SD card, built-in MIC.
- 12 VDC/PoE power supply; ePoE.
- IP67 protection.
- SMD 3.0.



People Counting

With deep learning algorithm, Dahua People Counting technology can track and process moving human body targets to realize the accurate statistics of enter No., leave No., and In Area No. Working with management platform, it outputs reports to meet your requirements.

Video Metadata

With deep learning algorithm, Dahua Video Metadata technology can detect, track, capture vehicle, non-motor vehicle and people, and select the best images, and extract attributes.

Cyber Security

Dahua network cameras employ a series of security technologies, including security authentication and authorization, access control protocols, trusted protection, encrypted transmission and encrypted storage. These technologies improve the camera's defense against external cyber threats and prevent malicious programs from compromising the device.

Protection (IP67, Wide Voltage)

IP67: The camera passes a series of strict test on dust and soak. It has dust-proof function, and the enclosure can work normally after soaking in 1 m deep water for 30 minutes.

Wide voltage: The camera allows ±30% (for some power supplies) input voltage tolerance (wide voltage range), and it is widely applied to outdoor environment with instable voltage.

Technical Specification

Camera

Image Sensor	1/1.8" CMOS
Max. Resolution	3840 (H) × 2160 (V)
ROM	4 GB
RAM	2 GB
Scanning System	Progressive
Electronic Shutter Speed	Auto/Manual 1/3 s–1/100,000 s
Min. Illumination	0.0008 lux@F1.6 (Color, 30 IRE) 0.0004 lux@F1.6 (B/W, 30 IRE) 0 lux (Illuminator on)
S/N Ratio	>56 dB
Illumination Distance	Up to 50 m (164.04 ft) (IR)
Illuminator On/Off Control	Auto;Manual
Illuminator Number	2 (IR LED)
Angle Adjustment	Pan: 0°–360° Tilt: 0°–78° Rotation: 0°–360°

Lens

Lens Type	Fixed-focal
Lens Mount	M16
Focal Length	2.8mm; 3.6mm; 6mm
Max. Aperture	F1.6
Field of View	2.8 mm: H: 111°; V: 59°; D: 131° 3.6 mm: H: 87°; V: 47°; D: 102° 6 mm: H: 55°; V: 30°; D: 64°
Iris Control	Fixed
Close Focus Distance	2.8 mm: 1.8 m 3.6 mm: 2.6 m 6 mm: 4.4 m

DORI Distance	Lens	Detect	Observe	Recognize	Identify
	2.8 mm	85.4 m (280.18 ft)	34.2 m (112.20 ft)	17.1 m (56.10 ft)	8.5 m (27.89 ft)
3.6 mm	106.0 m (347.77 ft)	42.4 m (131.11 ft)	21.2 m (69.55 ft)	10.6 m (34.78 ft)	
6 mm	164.8 m (540.68 ft)	65.9 m (216.21 ft)	33.0 m (108.27 ft)	16.5 m (54.13 ft)	

*DORI (Detect, Observe, Recognize, Identify) is a standard system (EN-62676-4) for defining the ability of a person viewing the video to distinguish persons or objects within a covered area. The numbers in this table do not reflect intelligent function distances. For intelligent function distances, refer to installation and commissioning manual/project design tool.

Intelligence

EPTZ	Yes
------	-----

IVS (Perimeter Protection)	Intrusion, tripwire, fast moving (the three functions support the classification and accurate detection of vehicle and human); loitering detection, people gathering, and parking detection
Smart Object Detection	Smart abandoned object; smart missing object
SMD	SMD 3.0
AcuPick	Uses deep learning algorithms and works with back-end devices to accurately match targets, such as people and motor vehicles, and search through live and recorded videos to quickly locate targets.
AI SSA	Yes
Face Detection	Face detection; track; snapshot; snapshot optimization; optimal face snapshot upload; face enhancement; face exposure; face attributes extraction including 6 attributes and 8 expressions; face snapshot set as face, one-inch photo or custom; snapshot strategies (real-time snapshot, quality priority and optimization snapshot); face angle filter; optimization time setting.
People Counting	Tripwire people counting, generating and exporting report (day/week/month/year); people counting in area and queue management; generating and exporting report (day/week/month); 4 rules can be set for tripwire, people counting in area and queue management.
Heat Map	Yes
Video Metadata	Motor vehicle, non-motor vehicle, face, human body detection; track; snapshot; snapshot optimization; optimal face snapshot upload. Motor vehicle attributes: vehicle type, vehicle color, vehicle logo and other attributes : seatbelt, smoking, calling. Non-motor vehicle attributes: type, color, number of people, top type and color, hat. Human body attributes: gender, top/bottom type and color, bag, hat and umbrella. Face attributes: gender, age, expressions, glasses, face mask and beard.
Smart Search	Work together with Smart NVR to perform refine intelligent search, event extraction and merging to event videos
Smart Sound Detection	Yes
Video	
Video Compression	H.265; H.264; H.264H; H.264B; MJPEG (Only supported by the sub stream)
Smart Codec	Smart H.265+; Smart H.264+
AI Coding	AI H.265; AI H.264
Video Frame Rate	Main stream: 3840 × 2160@(1–25/30 fps) Sub stream: D1@(1–25/30 fps) Third stream: 1080p@(1–25/30 fps) Fourth stream: 720p@(1–10 fps) *The values above are the max. frame rates of each stream; for multiple streams, the values will be subjected to the total encoding capacity.
Stream Capability	4 streams
Resolution	3840 × 2160; 3072 × 2048; 3072 × 1728; 2592 × 1944; 2688 × 1520; 2560 × 1440; 2048 × 1535; 2304 × 1296; 1080p (1920 × 1080); 1.3M (1280 × 960); 720p (1280 × 720); D1 (704 × 576/704 × 480); VGA(640 × 480); CIF (352 × 288/352 × 240)
Bit Rate Control	CBR/VBR
Video Bit Rate	H.264: 32 kbps–16384 kbps H.265: 12 kbps–13568 kbps
Day/Night	Auto(ICR)/Color/B/W

BLC	Yes
HLC	Yes
WDR	120 dB
Scene Self-adaptation (SSA)	Yes
White Balance	Auto; natural; street lamp; outdoor; manual; regional custom
Gain Control	Auto
Noise Reduction	3D NR
Motion Detection	OFF/ON (4 areas, rectangular)
Region of Interest (Rol)	Yes (4 areas)
Smart Illumination	Yes
Defog	Yes
Image Rotation	0°/90°/180°/270° (Support 90°/270° with 4M (2688 × 1520) resolution and lower)
Mirror	Yes
Privacy Masking	8 areas
LDC	Yes (only 2.8mm/3.6mm supports)

Audio

Built-in MIC	Yes
Audio Compression	G.711a; G.711Mu; PCM; G.726; G.723

Alarm

Alarm Event	No SD card; SD card full; SD card error; network disconnection; IP conflict; illegal access; motion detection; video tampering; tripwire; intrusion; fast moving; abandoned object; missing object; loitering detection; people gathering; parking detection; scene changing; audio detection; voltage detection; external alarm; face detection; video metadata; SMD; people counting in area; stay detection; people counting; people number error detection; queue people number alarm; queue time alarm; security exception
-------------	---

Network

Network Port	RJ-45 (10/100 Enhancement Base-T)
SDK and API	Yes
Network Protocol	IPv4; IPv6; HTTP; TCP; UDP; ARP; RTP; RTSP; RTCP; RTMP; SMTP; FTP; SFTP; DHCP; DNS; DDNS; QoS; UPnP; NTP; Multicast; ICMP; IGMP; NFS; SAMBA; PPPoE; SNMP; P2P
Interoperability	ONVIF (Profile S/Profile G/Profile T); CGI;
User/Host	20 (Total bandwidth: 80 M)
Storage	FTP; SFTP; Micro SD card (support max. 512 GB); NAS
Browser	IE: IE 9 and later Chrome: Chrome 102 and later Firefox: Firefox 88 and later
Management Software	SmartPSS Lite; DSS; DMSS
Mobile Client	iOS; Android
Cyber Security	Configuration encryption; trusted execution; Digest; security logs; WSSE; account lockout; syslog; video encryption; 802.1x; IP/MAC filtering; HTTPS; trusted upgrade; trusted boot; firmware encryption; generation and importing of X.509 certification

Certification

Certifications	CE-LVD: EN62368-1 CE-EMC: Electromagnetic Compatibility Directive 2014/30/EU FCC: 47 CFR FCC Part 15, Subpart B UL/CUL: UL62368-1 & CAN/CSA C22.2 No. 62368-1-14
----------------	---

Port

Audio Input	1 channel (RCA port)
Audio Output	1 channel (RCA port)
Alarm Input	1 channel in: wet contact, 5mA 3V–5V DC
Alarm Output	1 channel out: wet contact, 300mA 12V DC

Power

Power Supply	12 VDC/PoE (802.3af)/ePoE
Dual Power Backup	When the power adapter and PoE provide power at the same time, disconnect one of them. The device will continue to work, but will not restart.
Power Consumption	Basic: 4.1 W (12 VDC); 5.2 W (PoE); Max. (H.265+ WDR+ Intelligence on+IR on): 6.8 W (12 VDC); 8.8 W (PoE)

Environment

Operating Temperature	–40 °C to +60 °C (–40 °F to +140 °F)
Operating Humidity	≤95%
Storage Temperature	–40 °C to +60 °C (–40 °F to +140 °F)
Storage Humidity	10%–95% (RH), non-condensing
Protection	IP67

Structure

Casing Material	Inner core: Metal Cover: Metal Decoration ring: Plastic Quick install mounting plate: Metal
Product Dimensions	99.1 mm × Φ121.9 mm (3.90" × Φ4.80")
Net Weight	500 g (1.10 lb)
Gross Weight	770 g (1.70 lb)

Ordering Information

Type	Model	Description
8MP Camera	DH-IPC-HDW5842TM-ASE	8MP IR Fixed-focal Eyeball WizMind Network Camera
	IPC-HDW5842TM-ASE	8MP IR Fixed-focal Eyeball WizMind Network Camera
Accessories (Optional)	PFA130-E	Water-proof Junction Box
	PFB205W-E	Wall Mount Bracket
	PFA152-E	Pole Mount Bracket
	PFA109	Mount adapter
	PFB220C	Ceiling Mount Bracket
	PFM321D	12 VDC 1 A Power Adapter
	PFM900-E	Integrated Mount Tester
TF-P100	MicroSD Memory Card	

Accessories

Optional:



PFA130-E
Water-proof
Junction Box



PFB205W-E
Wall Mount
Bracket



PFA152-E
Pole Mount Bracket



PFA109
Mount adapter



PFB220C
Ceiling Mount
Bracket



PFM321D
12 VDC 1 A Power
Adapter



PFM900-E
Integrated
Mount Tester



TF-P100
MicroSD
Memory Card

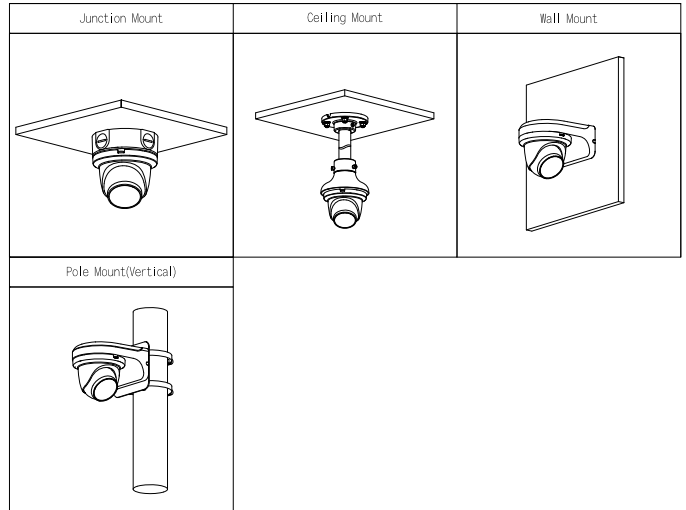

Dimensions (mm[inch])

