

**WISENET**

# **NETWORK VIDEO RECORDER**

Quick Manual







QRN-410S/810S/1610S







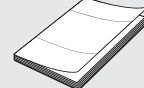

## Package Contents

 Accessory category and quantity may differ depending on sales region.





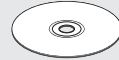
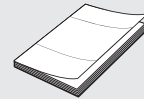
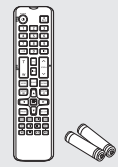

### QRN-410S

		
NVR	Mouse	Power Cable
		
Power Adaptor	User Manual CD	User Manual or Quick Manual
		
HDD Fixing Screw	SATA Cable	

### QRN-810S

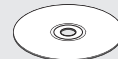
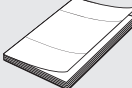
		
NVR	Mouse	Power Cable
		
Power Adaptor	User Manual CD	User Manual or Quick Manual
		
Remote Control / Remote Control Battery (AAA)	HDD Fixing Screw	SATA Cable

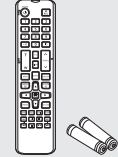
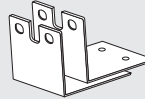
### QRN-1610S

		
NVR	Mouse	Power Cable
		
User Manual CD	User Manual or Quick Manual	Terminal block
		
Remote Control / Remote Control Battery (AAA)	Bracket rack	Bracket Fixing Screw

## HDD Installation

### QRN-410S/810S

 The following figures are based on Model QRN-810S.

- After unscrewing, push back and remove the cover.
- Connect the SATA/power cables of the HDD to the connectors on the mainboard.

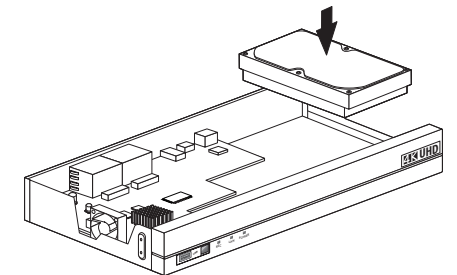
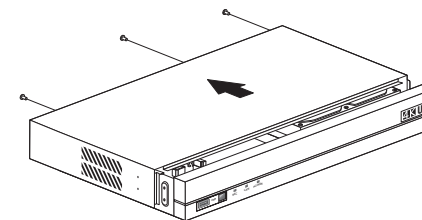

- Using the screws, fix the HDD to the bottom of the set.
- Check for any problems in the connection terminal and the wiring in the product, close the cover and fix it with screws.
  - Be careful not to damage the cables when you close the cover.

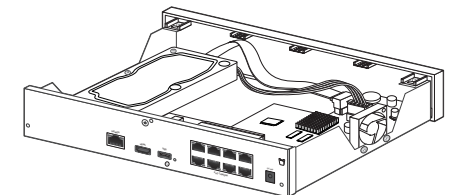
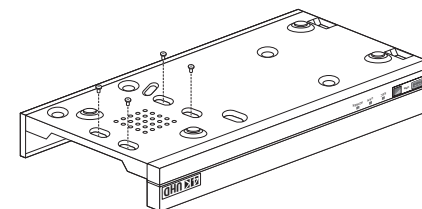

**5** Close the cover, and tighten a setscrew in the back.

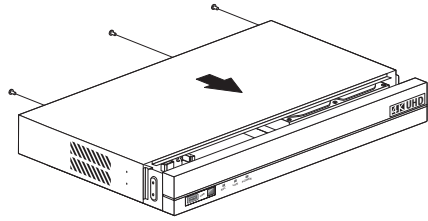

## QRN-1610S

**1** After unscrewing, push back and remove the cover.

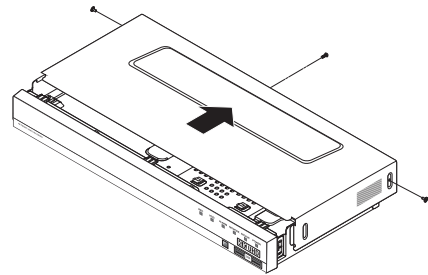

**2** Separate them by unscrewing the fixed bracket screw and push it towards the arrow on the board.

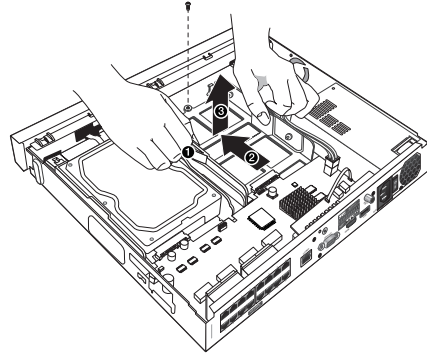

**3** After aligning and inserting one side of the HDD to the bracket, open the other side bracket wide and insert the HDD between them.

- Align a hole in the bracket with a screw hole in the HDD to fix them.

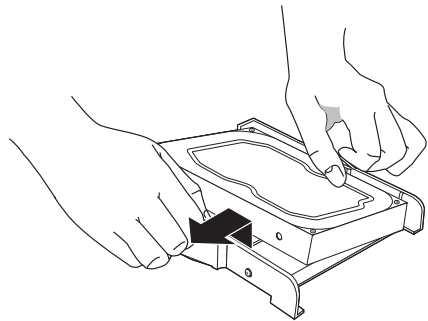

**4** Push the bracket with the HDD installed and tighten the screws to fix it.

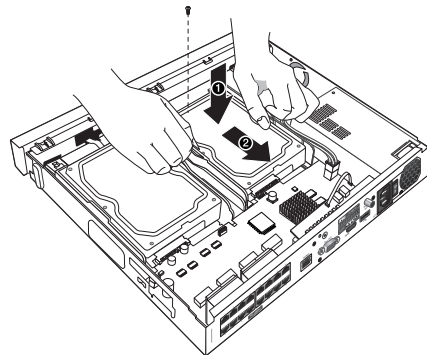

**5** Close the cover and tighten the screws to fix it.

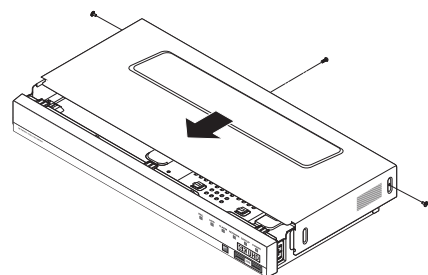

## Install Wizard

**1** Select the language

Select your preferred language.

**2** Set Password

Set a password.

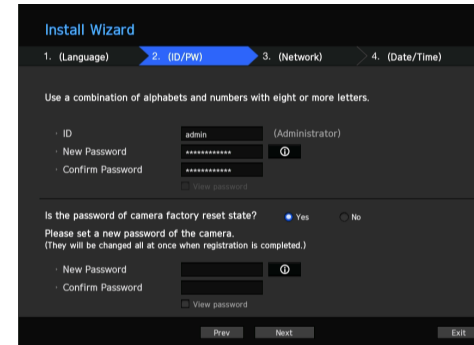

※ Click  icon to see the password rule

**8 ~ 9 characters** : All combination of English character, Digit, Special character

**10 ~ 15 characters** : Two combination of English character, Digit, Special character

※ Not allowed to use same characters with ID

※ Not allowed to use 4 or more continuative or repeated characters

### 2-1. Setting Camera Password

You can change the password of the camera one step.

If the password of the camera is the default password set in the factory, enter a new password to change it. The password will be changed, and the new password will be registered.

If the password of the camera is not the default password set in the factory, enter the current camera password. The current camera password will be registered.

- New Password : Input a new password according to the password setting rules.

- Confirm Password : Input the new password again.

- A camera password registered with ONVIF and RTSP cannot be changed.

**3** Set up Network

• DHCP server : If the DHCP server is set to enable, an IP is automatically assigned to the camera.

• Network 1 (Camera) : Connects to the camera and receives the video feed from the camera.

• Network 2 (All) : Network for a remote viewer (SSM, Smart Viewer, Webviewer)

• Network 1 / Network 2 Setup

- IP Type : Choose the network connection method.

- IP Address, Subnet Mask, Gateway, DNS

• Switch Mode : PnP Mode and Manual Setup Mode

If PnP Mode is selected, NVR will assign IP address to the IP cameras automatically.

If Manual Setup Mode is selected, you need to search and add the IP cameras to the NVR.

※ For more details on network settings, refer to the User manual.

▶ To use a simple intranet, click **<Next>**.

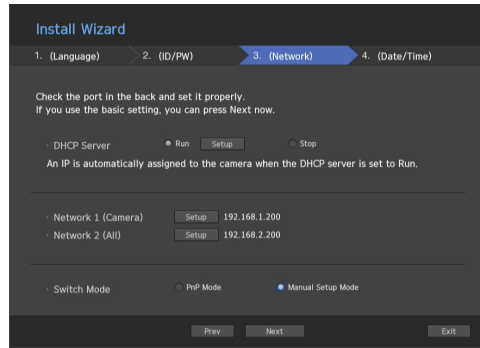

#### 4 Set Date & Time

Set the time and date and click the <Finish> button, and the installation will be completed.

#### 5 Camera Registration

When the installation wizard finishes, the camera is automatically registered.

5-1. If there are 16 or less cameras searched, it will be automatically registered and the camera information (fps, days of recording) will be displayed.

- ▶ Select <OK> and the frame rate of all cameras registered is set to 30fps and the installation session is completed.
- ▶ When you select <Manual Setting>, the frame rate of all cameras registered can be set to a value selected by the user (move to 5-2).

#### 5-2. Adjust the recording framerate

Changes the recording frame rate for all cameras at once.

Please note that the estimated recording days vary depending on the frame rate.



< Figure 5-1 >

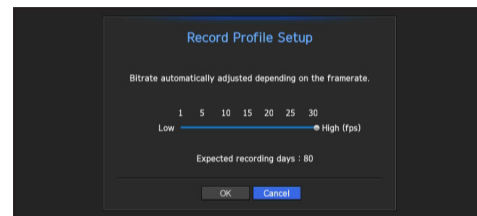

< Figure 5-2 >

5-3. If there are more than 16 cameras searched, Camera registration window will be displayed.

Select a camera to register and click the <Register> button. Once camera registration is finished, proceed in 5-1.

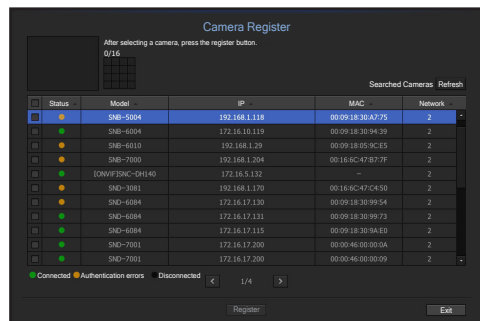

< Figure 5-3 >

## Additional camera registration

In the <Install Wizard> setting, make a connection to the camera automatically registered and use the menu path to register and connect a camera.

Menu → Device → Camera → Cam Registration → Auto

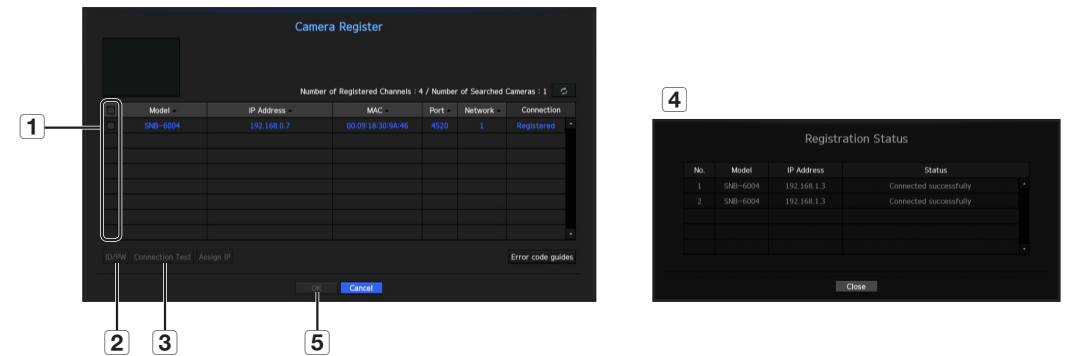

To register a camera, follow these steps:

- 1 Select the camera to register (you can select multiple cameras).
  - 2 Click <ID/PW> to register your ID and password. (If you do not register a new ID/PW, then the default ID/PW combination is used.)
  - 3 Click <Connection Test>.
  - 4 Check the connection results.
  - 5 If the channel connected successfully, click <OK> to end the camera registration process.
- Click an item on the table to see a preview (you must change the ID/PW in step 2 if the camera account changes).
  - Click the table headers to sort the content.
  - Click <↻> to check if a new IP address was allocated to the camera when you rescan the network or when an IP address was not assigned by the DHCP server (e.g., 192.168.1.100). If the IP still stays the same, then select Assign IP to assign the IP manually.

## Configuring the Recording

This section outlines how to configure and view the recording settings for each channel.

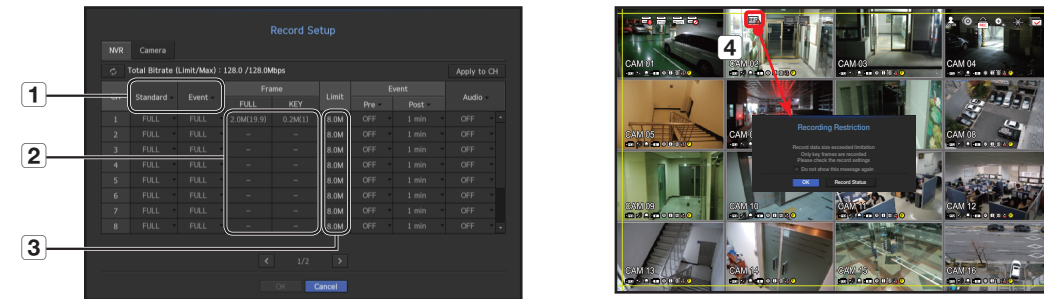

- 1 Shows the standard and event recording method for each channel.
  - FULL : Records all the frames received from the camera.
  - KEY : Records only the key frames received from the camera. In general, one or two frames per second are recorded, but you can adjust this in the camera settings.
  - OFF : Turns off recording.
- 2 Shows the transmission size of the recording data for each channel.
- 3 Shows the data size limit for each channel.
  - The orange colored channel indicates the case where the 2 input data load is greater than the 3 permitted data load. If you set the 3 permitted data load to greater than the 2 input data loads, it will be changed to orange.
  - If the sum of input data for each channel is greater than the max level for the camera, then 4 the recording exceeding icon and the alarm message will be displayed. In this case, for the channel exceeding the input limit will record the main frame(one or two per second) only.

## Setting Up the Camera

From the setup menu, you can configure the camera settings (resolution, frame rate, and quality) and other functional settings.

Menu → Device → Camera → Camera setup

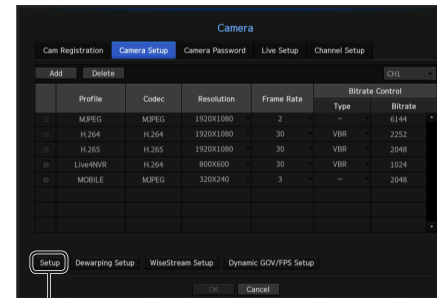

Camera function settings: You can configure the camera settings or the live movie format to change the settings in the camera itself.

- Add : Adds a camera profile.
- Delete : Deletes the selected profile from the list.
- Profile : Specifies the movie profile of the connected camera in the camera settings.
- Codec : You cannot change the codec of the selected profile.
- Resolution : Specifies the resolution of the selected profile.
- Frame Rate : Specifies the frame rate of the selected profile.
- Bitrate Control : Specifies the bitrate of the video transmitted for the selected profile.

## Setting Up a Channel

From the channel setup menu, you can change the camera name shown in live mode.

Menu → Device → Camera → Channel setup

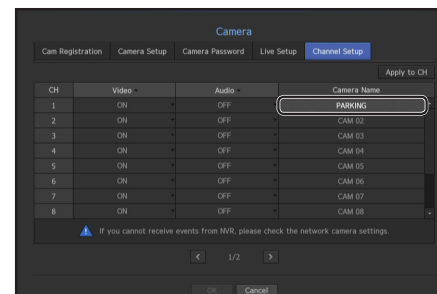

## Use the basic guide

### Show shortcut menu

Right-click on the live screen and you can access various functions that NVR provides. Hover over an icon and a brief definition of term for each function is prompted.

The diagram illustrates the 'Show shortcut menu' feature. On the left, a vertical menu lists various functions: Full Screen, Layout, Keep ch. scr ratio, Status, PTZ Control, ZOOM, Audio, Freeze, Stop Alarm, Capture, Record, Play, Search, Backup, Menu, Quick Setup, Shutdown, Logout, and Hide Launcher. On the right, three screenshots show the live screen interface with arrows pointing from the menu items to their corresponding locations on the screen:

- Status:** Points to the 'Status' icon in the top right corner of the live screen.
- ZOOM:** Points to the 'ZOOM' icon in the top right corner of the live screen.
- Menu:** Points to the 'Menu' icon in the top right corner of the live screen.

The live screen interface includes a 'Connection' dialog box with a 4x4 grid of camera status indicators (1-16) and a 'Close' button. The status indicators show 'Not used', 'Connected', 'Recording', and 'Connection Error'.

The 'Setup' menu is also shown, with options for System, Date/Time/Language, User, System Management, Log Information, Record, Event, and Network.

## Live launcher



- 1 You can configure a live layout.
- 2 You can configure a supported split mode. You can view the end sequence (16) in serial order for a specific period of time for each split mode.
- 3 You can configure additional functions in the live screen, such as alarm control or audio.

## Layout

In the live screen, you can set the layout for each channel.

This section outlines how to select a series of channels based on their purpose/accessibility and monitor them in a single layout.

Example) Layout "Lobby" - Lobby camera 1, Lobby camera 2, Front entrance camera 2

Layout "VIP" - Directors' meeting room 1, Directors' meeting room 2, Directors' lounge 1, Corridor camera on the 7th floor

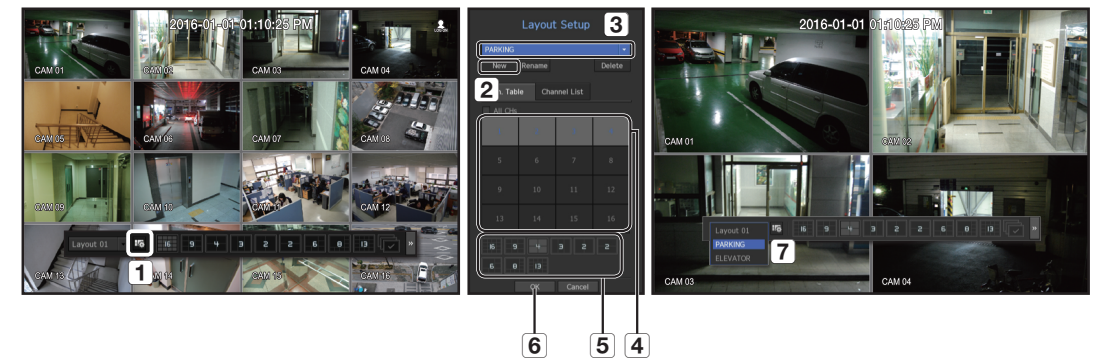

To create a new layout, follow these steps:

- 1 Open the channel layout setup menu.
- 2 Click <New>.
- 3 Enter a name for the selected channels (e.g., PARKING).
- 4 Select the channels that you want to add to the layout (e.g., 1, 2, 3, 4).
- 5 Choose a split mode to apply (e.g., 4-way split).
- 6 Click <OK>.
- 7 Choose a layout to view it on the screen (e.g., change to PARKING).

## Using P2P Service

When using P2P service, NVR can be used by connecting to mobile web viewer.

- 1 When **<Enable P2P>** is checked, the connection test runs to check if it can be remotely connected from the current NVR.

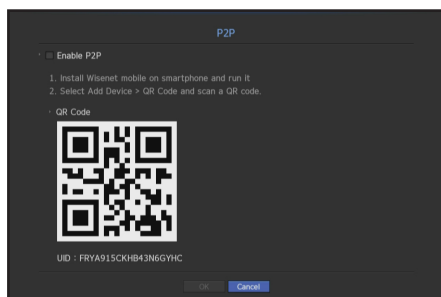

- 2 When the connection is successful, search for WiseNet Mobile from the smart phone, and then install and run it.
  - When Add a device > QR code is selected, the NVR QR code can be scanned.
- 3 When the QR code is scanned, the device ID that can be seen in NVR is automatically converted to mobile viewer ID, and the mobile viewer can be used right away when the ID/password of NVR is entered.

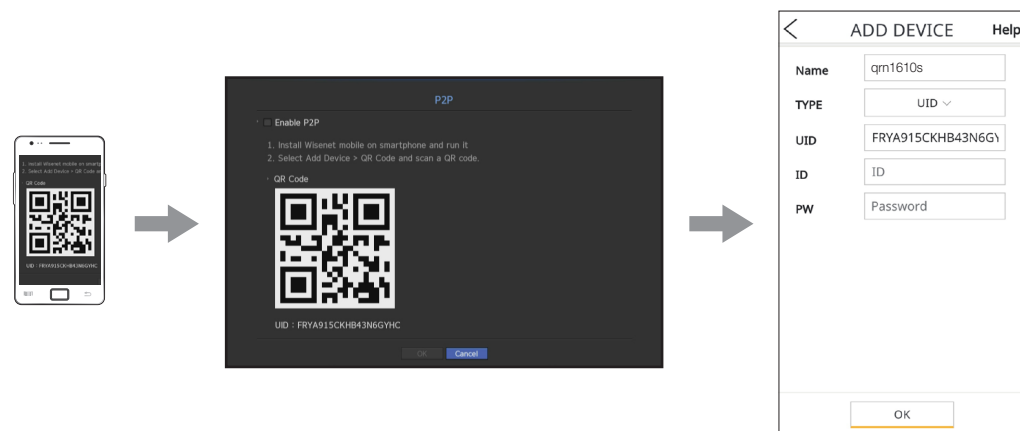

- 4 After this, it automatically connects to NVR and can be monitored easily with a smart phone when running WiseNet mobile app saved in the smart phone.



- The expiration date for the P2P service is three years after the purchase of the product, and the remaining period can be checked in mobile FAQ.

## Use product information

You can check product information/user manual/firmware information/FAQ/HDD compatibility list, etc. on the website or mobile app on your smartphone.

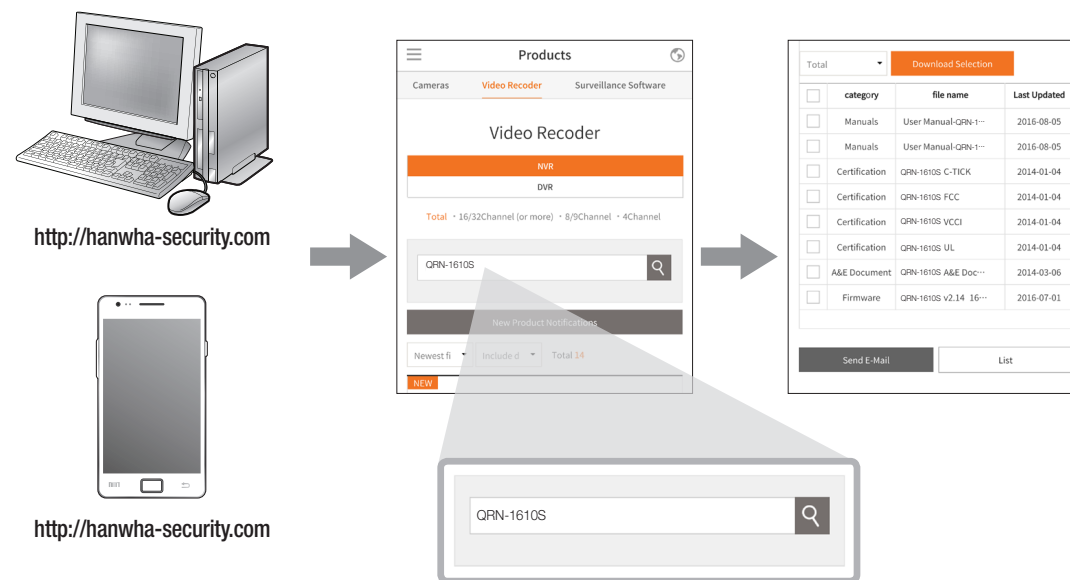

Hanwha Techwin cares for the environment at all product manufacturing stages, and is taking measures to provide customers with more environmentally friendly products. The Eco mark represents Hanwha Techwin's devotion to creating environmentally friendly products, and indicates that the product satisfies the EU RoHS Directive.



### Correct Disposal of This Product (Waste Electrical & Electronic Equipment)

(Applicable in the European Union and other European countries with separate collection systems)

This marking on the product, accessories or literature indicates that the product and its electronic accessories (e.g. charger, headset, USB cable) should not be disposed of with other household waste at the end of their working life. To prevent possible harm to the environment or human health from uncontrolled waste disposal, please separate these items from other types of waste and recycle them responsibly to promote the sustainable reuse of material resources.

Household users should contact either the retailer where they purchased this product, or their local government office, for details of where and how they can take these items for environmentally safe recycling.

Business users should contact their supplier and check the terms and conditions of the purchase contract. This product and its electronic accessories should not be mixed with other commercial wastes for disposal.



### Correct disposal of batteries in this product

(Applicable in the European Union and other European countries with separate battery return systems.)

This marking on the battery, manual or packaging indicates that the batteries in this product should not be disposed of with other household waste at the end of their working life. Where marked, the chemical symbols Hg, Cd or Pb indicate that the battery contains mercury, cadmium or lead above the reference levels in EC Directive 2006/66. If batteries are not properly disposed of, these substances can cause harm to human health or the environment.

To protect natural resources and to promote material reuse, please separate batteries from other types of waste and recycle them through your local, free battery return system.

---

**Head Office**

6, Pangyo-ro 319 beon-gil, Bundang-gu, Seongnam-si,  
Gyeonggi-do, 463-400 Rep. of KOREA  
Tel : +82.70.7147.8753 Fax : +82.31.8018.3740  
<http://hanwha-security.com>

---

**Hanwha Techwin America**

500 Frank W. Burr Blvd. Suite 43 Teaneck, NJ 07666  
Toll Free : +1.877.213.1222 Direct : +1.201.325.6920  
Fax : +1.201.373.0124  
[www.hanwha-security.com](http://www.hanwha-security.com)

---

**Hanwha Techwin Europe**

Heriot House, Heriot Road, Chertsey, Surrey, KT16 9DT, United Kingdom  
Tel : +44.1932.57.8100 Fax : +44.1932.57.8101  
[www.hanwha-security.eu](http://www.hanwha-security.eu)

---

**Hanwha Techwin(Tianjin) Co.Ltd**

No.11, Weiliu Rd., Micro-Electronic Industrial Park, Jingang Road Tianjin 300385, China  
Tel : +86.22.2388.7788  
[www.hanwha-security.cn](http://www.hanwha-security.cn)

---

**Hanwha Techwin Middle East FZE**

JAFZA View 18, 20th floor, office 2001, 2002, 2003, Downtown Jebel Ali,  
Dubai, United Arab Emirates  
<http://hanwha-security.com>

---