

DS-MP5604 Series Mobile Video Recorder

Key Feature

- User-friendly GUI providing easy and flexible operations.
- Pluggable 3G/4G module and Wi-Fi module providing flexible data transmission solutions.
- Built-in GPS module precisely positioning the vehicle via the satellite and recording the location information in the video stream.
- Hikvision private protocol supported.
- Access of 4 HD TVI cameras with up to 1080p resolution.
- Access of 4 IP cameras with up to 1080p resolution.
- Pluggable dummy HDD for HDD with up to 2 TB capacity.
- Information collection interfaces collecting driving information such as left/right turn, braking, reversing, etc.
- Specialized aviation connectors ensuring signal stability.
- Shutdown delay (0 h to 6 h) and 24-hour scheduled startup/shutdown.
- Battery protection avoids vehicle from running out of battery.
- Wide-range power input (+9 VDC to +32 VDC).
- Power-off protection prevents key data loss.
- Aluminum die-cast chassis with no fan design well adaptable to working environment.
- Software-based firewall supported.
- Connectable to PTZ camera and PTZ control is supported.
- Support accessing via WEB browser.



Available Model

DS-MP5604,

DS-MP5604 + DS-MP1460/GW, (supports 3G dialing),

DS-MP5604 + DS-MP1460/GLF, (supports 4G dialing),

DS-MP5604 + DS-MP1460/GW/WI58, (supports 3G dialing and 5.8G Wi-Fi),

DS-MP5604 + DS-MP1460/GLF/WI58, (supports 4G dialing and 5.8G Wi-Fi)

* 3G/4G and Wi-Fi functions are supported only when DS-MP1460 Mobile Wireless Component is equipped with DS-MP5604.



Specification

Model		DS-MP5604
Video/Audio Input	Analog Camera	4 analog cameras, up to 1080p resolution
	IP Camera	4 IP cameras, up to 1080p resolution (extendable via PoE switch)
	Two-way Audio	1, integrated in EXT.DEV interface
Video/Audio Output	Video Output	Main output: 1, integrated in EXT.DEV interface VGA: 1
	Audio Output	1
Encoding/Decoding Parameters	Video Compression	H.264/H.265
	Encoding Resolution	Main stream: 1080p/720p/WD1/4CIF Sub-stream: 4CIF/2CIF/CIF
	Frame Rate	<ul style="list-style-type: none"> ● PAL: 1 to 12 fps@1080P; NTSC: 1 to 12 fps@1080P; ● PAL: 1 to 25 fps@720P; NTSC: 1 to 30 fps@720P
	Audio Compression	G.711/G.722.1
	Stream Type	Video, video & audio
	Audio Bitrate	16 Kbps
	Dual Stream	Supported
Storage	HDD/SSD	1 × 2.5 inch HDD/SSD, up to 2 TB for each HDD/SSD (A dummy HDD with 2 HDD/SSDs can be extended.) A dummy HDD with USB 3.0 interface
	SD Card	1 × SD card, up to 256 GB
Wireless Network	3G/4G Dialing	1 × 3G/4G card slot, 1 × Rosenberger antenna (Optional. WCDMA and FDD-LTE modules are supported.)
	Wi-Fi	WI58 model: 2 × 5.8 G Wi-Fi SMA antenna (Optional. 802.11B/G/N and 802.11AC are selectable. 1 antenna is needed for 802.11B/G/N module. 2 antennas are needed for 802.11AC module.)
Positioning	GNSS (Global Navigation Satellite System)	GPS (Global Positioning System) & GLONASS (Global Navigation Satellite System), 1 × Rosenberger antenna
G-Sensor	G-Sensor	Built-in
External Interface	Network Interface	1 × 10M/100M M12 6-pin aviation connector
	Serial Port	2 × RS-232, 1 × RS-422 (integrated in EXT.DEV interface)
	USB Interface	<ul style="list-style-type: none"> ● Front panel: 1 × USB 2.0 ● Rear panel: 1 × USB 2.0 (5-pin aviation connector)
	Sensor-in	4 high/low level signal inputs
	Alarm Input	4 high/low level signal inputs, 1 pulse signal input, 1 BUTTON input
	Alarm Output	2 relay signal outputs
General	Operating Method	Mouse, IR remote control, Web control, and touchscreen
	Power Supply	9 to 32 VDC
	Consumption	<ul style="list-style-type: none"> ● Standby: ≤ 0.5 W ● Full load: ≤ 45 W Note: Without peripheral and storage media ≤ 20 W
	Working Temperature	<ul style="list-style-type: none"> ● Device that provides dummy HDD with heating function: -30 °C to +60 °C (-22 °F to +140°F)

	● Other devices: -10 °C to +60 °C (+14 °F to +140°F)
Working Humidity	10% to 95%
Dimension (W × D × H)	206 × 225.4 × 60.1 mm (8.1 × 8.87 × 2.37 inch)
Weight (Without Storage Media)	1.7 kg (3.7 lb)

Physical Interface

Front Panel

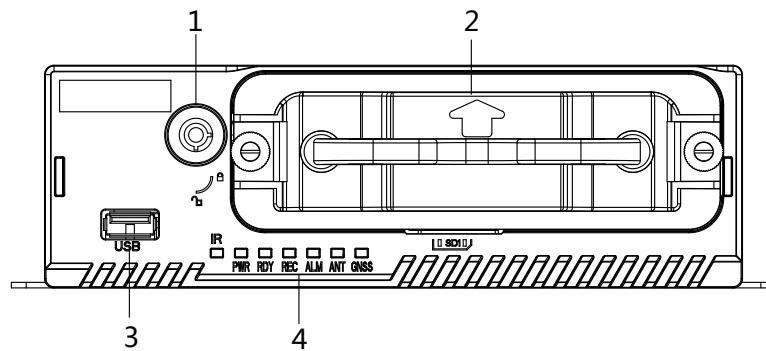

No.	Name	No.	Name
1	Dummy HDD/SSD lock	4	PWR: Power indicator
2	Dummy HDD/SSD		RDY: Ready indicator
3	USB 2.0 interface		REC: Record indicator
			ALM: Alarm indicator
			ANT: Dialing indicator
			GNSS: GPS indicator

Rear Panel

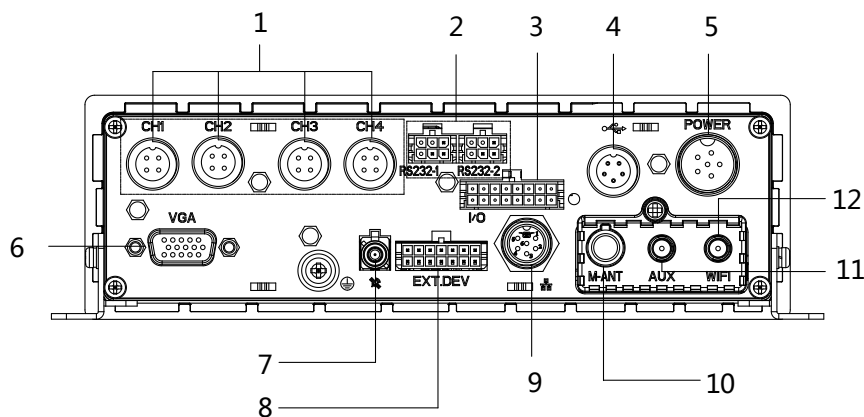

No.	Name	No.	Name
1	Analog camera input	7	GNSS antenna interface
2	RS-232 interface	8	RS-422 communication interface, two-way audio interface, and CVBS video output
3	Alarm in, alarm out, and sensor-in	9	Network interface
4	USB 2.0 of 5-pin aviation connector	10	3G/4G dialing antenna interface
5	Power supply	11	Auxiliary Wi-Fi antenna interface
6	VGA video output interface	12	Wi-Fi antenna interface

Packing List

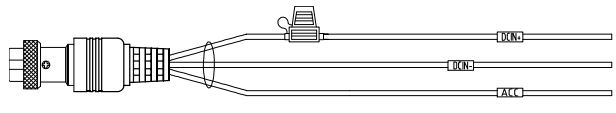
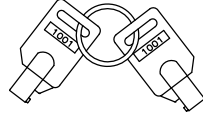
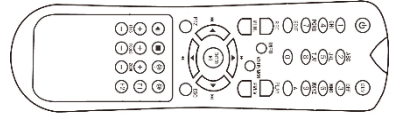
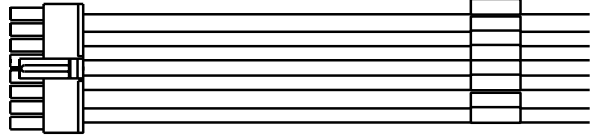
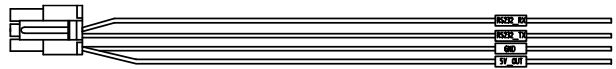
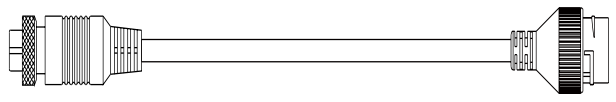
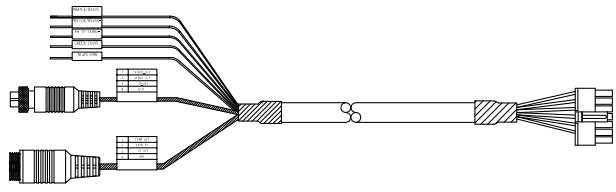
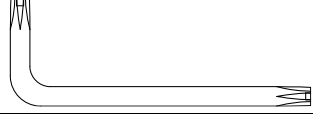
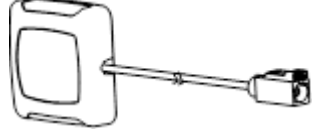
Description	Quantity	Picture	Note
Fuse	2		
Power cord	1		
Key	1		
Remote control	1		
Alarm line	1		
RS-232 line	1		
Switching line of 6-pin connector to RJ45 interface	1		
Extension cable	1		
Screwdriver	1		
GPS antenna	1		

Peripheral Connection

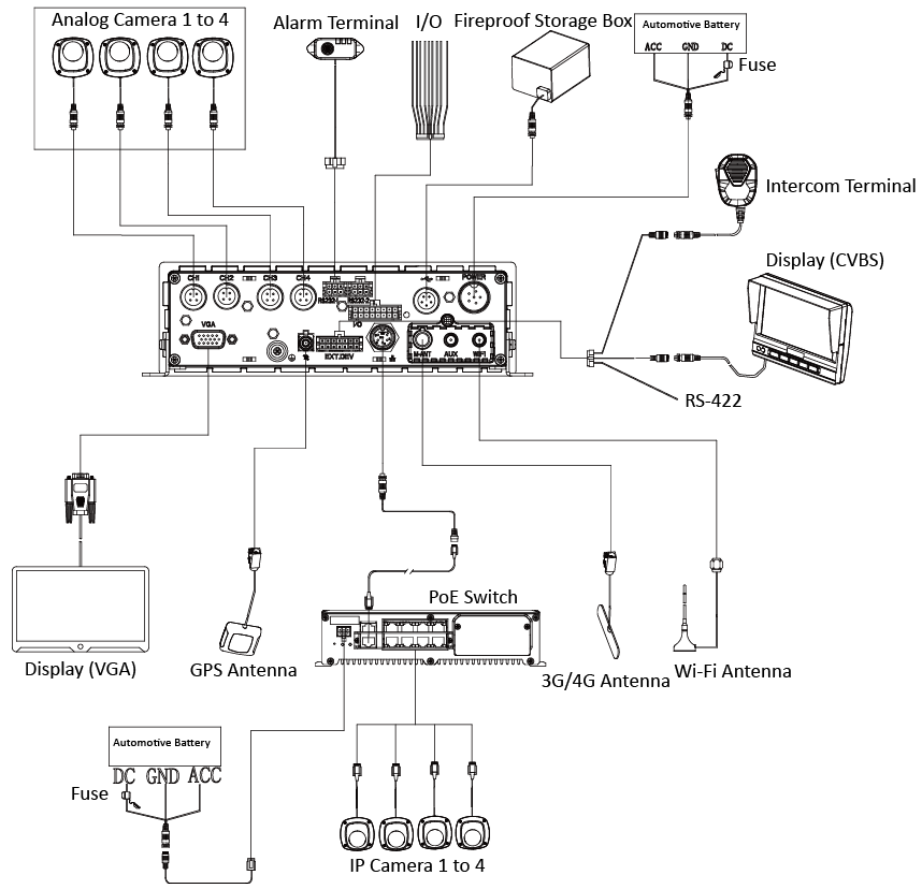

Distributed by

HIKVISION®

Headquarters

No.555 Qianmo Road, Binjiang District,
Hangzhou 310051, China
T +86-571-8807-5998
overseasbusiness@hikvision.com

Hikvision USA
T +1-909-895-0400
sales.usa@hikvision.com

Hikvision Australia
T +61-2-8599-4233
salesau@hikvision.com

Hikvision India
T +91-22-28469900
sales@pramahikvision.com

Hikvision Canada
T +1-866-200-6690
sales.canada@hikvision.com

Hikvision Thailand
T +662-275-9949
sales.thailand@hikvision.com

Hikvision Europe
T +31-23-5542770
sales.eu@hikvision.com

Hikvision Italy
T +39-0438-6902
info.it@hikvision.com

Hikvision Brazil
T +55 11 3318-0050
Latam.support@hikvision.com

Hikvision Turkey
T +90 (216)521 7070- 7074
sales.tr@hikvision.com

Hikvision Malaysia
T +601-7652-2413
sales.my@hikvision.com

Hikvision UK & Ireland
T +01628-902140
sales.uk@hikvision.com

Hikvision South Africa
Tel: +27 (10) 0351172
sale.africa@hikvision.com

Hikvision France
T +33(0)1-85-330-450
info.fr@hikvision.com

Hikvision Kazakhstan
T +7-727-9730667
nikia.panfilov@hikvision.ru

Hikvision Vietnam
T +84-974270888
sales.vt@hikvision.com

Hikvision UAE
T +971-4-4432090
salesme@hikvision.com

Hikvision Singapore
T +65-6684-4718
sg@hikvision.com

Hikvision Spain
T +34-91-737-16-55
info.es@hikvision.com

Hikvision Tashkent
T +99-87-1238-9438
uzb@hikvision.ru

Hikvision Hong Kong
T +852-2151-1761
info.hk@hikvision.com

Hikvision Russia
T +7-495-669-67-99
sateru@hikvision.com

Hikvision Korea
T +82-(0)31-731-8817
sales.korea@hikvision.com

Hikvision Poland
T +48-22-460-01-50
info.pl@hikvision.com

Hikvision Indonesia
T +62-21-2933759
Sales.Indonesia@hikvision.com

Hikvision Colombia
sales.colombia@hikvision.com