

**HIKVISION**

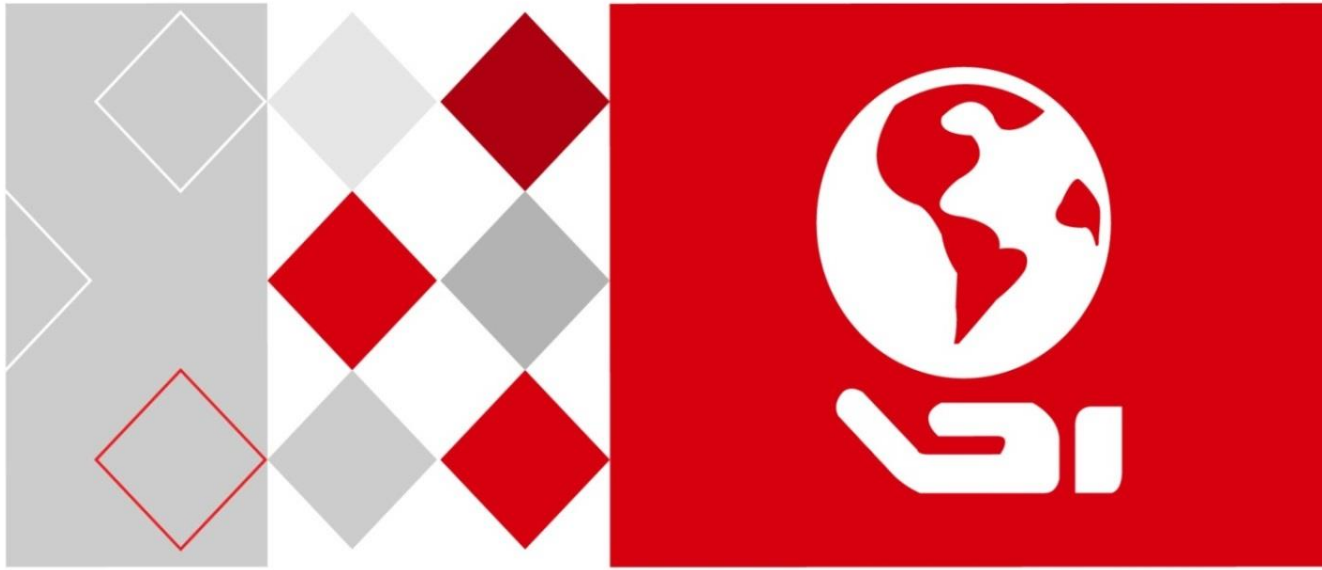

## HD Video and Audio Decoder

User Manual

UD02829B

## **User Manual**

COPYRIGHT ©2016 Hangzhou Hikvision Digital Technology Co., Ltd.

### **ALL RIGHTS RESERVED.**

Any and all information, including, among others, wordings, pictures, graphs are the properties of Hangzhou Hikvision Digital Technology Co., Ltd. or its subsidiaries (hereinafter referred to be “Hikvision”). This user manual (hereinafter referred to be “the Manual”) cannot be reproduced, changed, translated, or distributed, partially or wholly, by any means, without the prior written permission of Hikvision. Unless otherwise stipulated, Hikvision does not make any warranties, guarantees or representations, express or implied, regarding to the Manual.

### **About this Manual**

This Manual is applicable to DS-6900UDI Decoder.

The Manual includes instructions for using and managing the product. Pictures, charts, images and all other information hereinafter are for description and explanation only. The information contained in the Manual is subject to change, without notice, due to firmware updates or other reasons. Please find the latest version in the company website (<http://overseas.hikvision.com/en/>).

Please use this user manual under the guidance of professionals.

### **Trademarks Acknowledgement**

**HIKVISION** and other Hikvision’s trademarks and logos are the properties of Hikvision in various jurisdictions. Other trademarks and logos mentioned below are the properties of their respective owners.

### **Legal Disclaimer**

TO THE MAXIMUM EXTENT PERMITTED BY APPLICABLE LAW, THE PRODUCT DESCRIBED, WITH ITS HARDWARE, SOFTWARE AND FIRMWARE, IS PROVIDED “AS IS”, WITH ALL FAULTS AND ERRORS, AND HIKVISION MAKES NO WARRANTIES, EXPRESS OR IMPLIED, INCLUDING WITHOUT LIMITATION, MERCHANTABILITY, SATISFACTORY QUALITY, FITNESS FOR A PARTICULAR PURPOSE, AND NON-INFRINGEMENT OF THIRD PARTY. IN NO EVENT WILL HIKVISION, ITS DIRECTORS, OFFICERS, EMPLOYEES, OR AGENTS BE LIABLE TO YOU FOR ANY SPECIAL, CONSEQUENTIAL, INCIDENTAL, OR INDIRECT DAMAGES, INCLUDING, AMONG OTHERS, DAMAGES FOR LOSS OF BUSINESS PROFITS, BUSINESS INTERRUPTION, OR LOSS OF DATA OR DOCUMENTATION, IN CONNECTION WITH THE USE OF THIS PRODUCT, EVEN IF HIKVISION HAS BEEN ADVISED OF THE POSSIBILITY OF SUCH DAMAGES.

REGARDING TO THE PRODUCT WITH INTERNET ACCESS, THE USE OF PRODUCT SHALL BE WHOLLY AT YOUR OWN RISKS. HIKVISION SHALL NOT TAKE ANY RESPONSIBILITIES FOR ABNORMAL OPERATION, PRIVACY LEAKAGE OR OTHER DAMAGES RESULTING FROM CYBER ATTACK, HACKER ATTACK, VIRUS INSPECTION, OR OTHER INTERNET SECURITY RISKS; HOWEVER, HIKVISION WILL PROVIDE TIMELY TECHNICAL SUPPORT IF REQUIRED.

SURVEILLANCE LAWS VARY BY JURISDICTION. PLEASE CHECK ALL RELEVANT LAWS IN YOUR JURISDICTION BEFORE USING THIS PRODUCT IN ORDER TO ENSURE THAT YOUR USE CONFORMS THE APPLICABLE LAW. HIKVISION SHALL NOT BE LIABLE IN THE EVENT THAT THIS PRODUCT IS USED WITH ILLEGITIMATE PURPOSES.

IN THE EVENT OF ANY CONFLICTS BETWEEN THIS MANUAL AND THE APPLICABLE LAW, THE LATER PREVAILS.

## Regulatory information

### FCC information

Please take attention that changes or modification not expressly approved by the party responsible for compliance could void the user's authority to operate the equipment.

**FCC compliance:** This equipment has been tested and found to comply with the limits for a Class A digital device, pursuant to part 15 of the FCC Rules. These limits are designed to provide reasonable protection against harmful interference when the equipment is operated in a commercial environment. This equipment generates, uses, and can radiate radio frequency energy and, if not installed and used in accordance with the instruction manual, may cause harmful interference to radio communications. Operation of this equipment in a residential area is likely to cause harmful interference in which case the user will be required to correct the interference at his own expense.

### FCC conditions

This device complies with part 15 of the FCC Rules. Operation is subject to the following two conditions:

1. This device may not cause harmful interference.
2. This device must accept any interference received, including interference that may cause undesired operation.

### EU Conformity Statement

 This product and - if applicable - the supplied accessories too are marked with "CE" and comply therefore with the applicable harmonized European standards listed under the EMC Directive 2014/30/EU, the LVD Directive 2014/35/EU, the RoHS Directive 2011/65/EU.

 2012/19/EU (WEEE directive): Products marked with this symbol cannot be disposed of as unsorted municipal waste in the European Union. For proper recycling, return this product to your local supplier upon the purchase of equivalent new equipment, or dispose of it at designated collection points. For more information see: [www.recyclethis.info](http://www.recyclethis.info)

 2006/66/EC (battery directive): This product contains a battery that cannot be disposed of as unsorted municipal waste in the European Union. See the product documentation for specific battery information. The battery is marked with this symbol, which may include lettering to indicate cadmium (Cd), lead (Pb), or mercury (Hg). For proper recycling, return the battery to your supplier or to a designated collection point. For more information see: [www.recyclethis.info](http://www.recyclethis.info)

### Industry Canada ICES-003 Compliance



This device meets the CAN ICES-3 (A)/NMB-3(A) standards requirements.

## Applicable Model

Series	Model
DS-6900UDI Decoder	DS-6901UDI
	DS-6904UDI
	DS-6908UDI
	DS-6910UDI
	DS-6912UDI
	DS-6916UDI

## Symbol Conventions

The symbols that may be found in this document are defined as follows.

Symbol	Description
 <b>NOTE</b>	Provides additional information to emphasize or supplement important points of the main text.
 <b>WARNING</b>	Indicates a potentially hazardous situation, which if not avoided, could result in equipment damage, data loss, performance degradation, or unexpected results.
 <b>DANGER</b>	Indicates a hazard with a high level of risk, which if not avoided, will result in death or serious injury.

## Safety Instructions

- Proper configuration of all passwords and other security settings is the responsibility of the installer and/or end-user.
- In the use of the product, you must be in strict compliance with the electrical safety regulations of the nation and region. Please refer to technical specifications for detailed information.
- Input voltage should meet both the SELV (Safety Extra Low Voltage) and the Limited Power Source with 100 to 240 VAC or 12 VDC according to the IEC60950-1 standard. Please refer to technical specifications for detailed information.
- Do not connect several devices to one power adapter as adapter overload may cause overheating or a fire hazard.
- Please make sure that the plug is firmly connected to the power socket.
- If smoke, odor or noise rise from the device, turn off the power at once and unplug the power cable, and then please contact the service center.

## Preventive and Cautionary Tips

Before connecting and operating your device, be advised of the following tips:

- Ensure unit is installed in a well-ventilated, dust-free environment.
- Unit is designed for indoor use only.
- Keep all liquids away from the device.
- Ensure environmental conditions meet factory specifications.
- Ensure unit is properly secured to a rack or shelf. Major shocks or jolts to the unit as a result of dropping it may cause damage to the sensitive electronics within the unit.
- Use the device in conjunction with an UPS if possible.
- Power down the unit before connecting and disconnecting accessories and peripherals.
- Improper use or replacement of the battery may result in explosion. Replace with the same or equivalent type only. Dispose of used batteries according to the instructions provided by the battery manufacturer.

# Table of Contents

Chapter 1 Introduction.....	1
1.1 Description .....	1
1.2 Features.....	1
Chapter 2 Panels and Connections.....	3
2.1 Front Panel .....	3
2.2 Rear Panel .....	5
Chapter 3 Getting Started .....	8
3.1 Activating via SADP Software .....	8
3.2 Activation via Web Browser .....	9
3.3 Activation via Client Software .....	10
Chapter 4 Decoder Configuration and Operation by Web Browser .....	13
4.1 Decoder Configuration .....	15
4.1.1 Checking Device Information .....	15
4.1.2 Configuring Time Settings .....	15
4.1.3 Configuring RS-485/RS-232 Serial Port .....	17
4.1.4 Configuring Basic Network Settings .....	18
4.1.5 Configuring DDNS Settings.....	19
4.1.6 Configuring Wi-Fi Settings.....	21
4.1.7 Configuring Stream Settings.....	24
4.1.8 Configuring Transparent Channel .....	25
4.1.9 Configuring Synchronous Output Settings.....	26
4.1.10 Configuring Personalized Settings.....	27
4.1.11 Managing User Account.....	27
4.1.12 Importing/Exporting Configuration Files .....	29
4.1.13 Maintenance .....	29
4.2 Setting Video Wall Layout .....	31
4.3 Configuring Decoding Output .....	32
4.4 Decoding Operation .....	35
4.4.1 Adding an Encoding Device.....	36
4.4.2 Modifying the Area and Added Encoding Device .....	39
4.4.3 Deleting the Area or Added Encoding Device .....	40
4.4.4 Decoding on the Video Wall.....	40

4.4.5 Switching Encoding Channel .....	44
4.4.6 Configuring Auto-Switch of Cameras .....	44
4.4.7 Window Roaming .....	45
4.4.8 Setting Scene .....	45
Chapter 5 Decoder Configuration and Operation by Client Software.....	47
5.1 Adding an Encoding/Decoding Device .....	48
5.2 Configuring Video Wall Settings .....	50
5.2.1 Configuring Video Wall Layout .....	50
5.2.2 Configuring Decoding Output .....	52
5.2.3 Configuring General Parameters of Video Wall .....	55
5.2.4 Configuring Virtual Screen .....	56
5.3 Displaying Video on Video Wall .....	58
5.3.1 Decoding and Displaying Video.....	59
5.3.2 Opening Window via Coordinate .....	61
5.3.3 Configuring Playback.....	62
5.3.4 Configuring Auto-Switch Decoding .....	64
5.3.5 Window Configuration .....	64
5.4 Decoding Thermal Network Camera .....	65
5.4.1 Configuring the Thermal Network Camera Parameters.....	65
5.4.2 Decoding Thermal Network Camera on the Video Wall .....	73
5.5 Remote Screen Control .....	74
5.5.1 Configuring the RSC Server .....	75
5.5.2 Remote Screen Control via RSC Server .....	76
5.6 Remote Configuration .....	79
5.6.1 Configuring Port Aggregation.....	80
5.6.2 Configuring Wi-Fi Settings.....	81
Chapter 6 Display via Wi-Fi Connection.....	84
Chapter 7 Appendix .....	85
7.1 Specifications .....	85
7.2 FAQ.....	89
7.3 List of Third-party IP Cameras Access .....	90

# Chapter 1 Introduction

## 1.1 Description

Designed for the high-definition video monitoring system, DS-6900UDI Decoder is developed on the basis of embedded hardware platform, ensuring high reliability and stability of system running.

DS-6900UDI Decoder is capable of simultaneous decoding video for 16-ch@12MP, 32-ch@8MP, 48-ch@5MP, 80-ch@3MP, 128-ch@1080p simultaneous decoding, and outputting decoded video via BNC, VGA, or HDMI interfaces, and it also supports multiple video stream formats like H.265, H.264+, H.264 and MPEG4. The decoded video can be displayed on video wall or large screen.

## 1.2 Features

### Powerful Decoding Capability

- DS-6901UDI provides HDMI, VGA, and BNC output interfaces.
- Up to 16-ch decoding at 12 MP resolution (DS-6916UDI).
- DS-6904UDI, DS-6908UDI, DS-6910UDI, DS-6912UDI, DS-6916UDI provide HDMI (adaptable to DVI-D) and BNC output interfaces.
- Up to 4K (3840 × 2160@30 Hz) via HDMI interface (only for even interface), and up to 1080p@60Hz via VGA interface.
- H.265+/H.265, H.264+/H.264, MPEG4 and MJPEG video stream formats.
- PS, RTP, TS, ES, HIK encapsulation formats.
- Supports window opening and window roaming.
- Three encoding levels: baseline, main, and high-profile.
- G.722, G711A, G726, G711U, MPEG2-L2, and AAC audio stream formats.
- Accessible by panoVu network camera.
- Accessible by thermal network camera and you can view the temperature measurement, dynamic fire source detection, ship detection and VCA information in live view and playback.
- You can enable or disable the smart information for the thermal network camera.

### Multiple Decoding Control Modes

- Two decoding modes: active decoding and passive decoding.
- Decoding output of remote video files.
- Supports HiDDNS.
- Decoding on video wall by directly linking cameras or by stream media forwarding.
- Gets stream and decodes via URL.



- Remotely controls DVR's or DVS's PTZ via transparent channel.
- Two-way audio.
- Supports multi-screen control with PC installed with RSC server.
- Supports Wi-Fi module access to display the signal from IOS/Android mobile phone or pad on video wall.
- Wi-Fi can be enabled via the Web browser or client software. You can get stream and decode the video on the video wall when Wi-Fi is enabled if no wired network can be accessed.
- Configurable LED width and height parameters when the LED is connected.
- Regular and irregular virtual screen configurable to display multiple signal sources and get rid of the restriction of physical screen.
- LCD output type configurable for the BNC and VGA outputs; LCD and LED output types configurable for HDMI outputs.
- You can configure what the video wall show when decoding ends and streaming fails via the Web browser and client software.
- Auto-switch of sub-stream configurable via the Web browser and client software.

### Integrated Capability

- Decoding video/audio stream accessed by ONIVF, RTP/RTSP protocols.
- Provides complete software development kit (SDK) for third-party developers.
- Port link aggregation technology (Ethernet Channel).

### Maintenance Management

- Remotely get, configure, export and import parameters.
- Remotely reboot, restore default settings and upgrading via web browser or client software.

# Chapter 2 Panels and Connections

## 2.1 Front Panel

- Front panel of DS-6901UDI

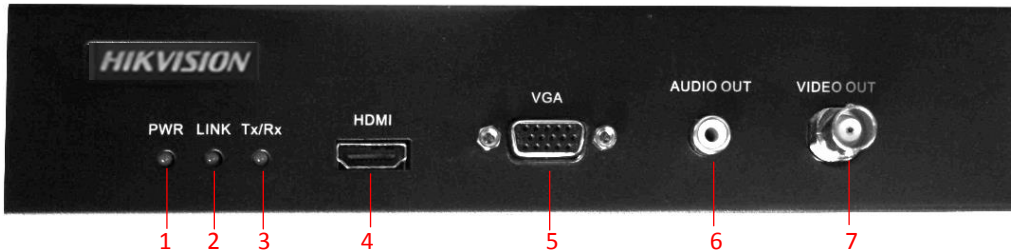

Figure 2-1 Front Panel of DS-6901UDI

Table 2-1 Description of DS-6901UDI Front Panel

No.	LED Indicator & Interface	Description
1	POWER	Power indicator
2	LINK	Network connection indicator
3	Tx/Rx	Data transmitting/receiving status indicator
4	HDMI video output	HDMI output for decoded video
5	VGA video output	VGA output of decoded video
6	Audio output	Audio output, 3.5mm connector
7	Video output	Video output, BNC connector

- Front Panel of DS-6904/6908UDI

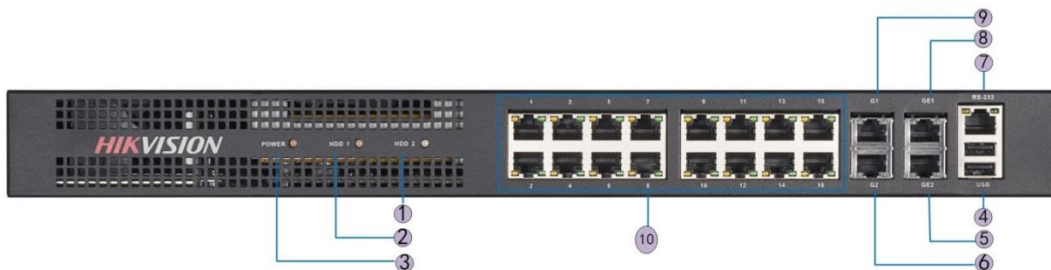

Figure 2-2 Front Panel of DS-6904/6908UDI

Table 2-2 Description of DS-6904/6908UDI Front Panel

	LED Indicator & Interface	Connections
1	Power	Power indicator
2	HDD1	Hard disk 1 indicator (Reserved)
3	HDD2	Hard disk 2 indicator (Reserved)
4	USB	USB 2.0 interface
5	GE2	Local management network interface 2
6	G2	10/100/1000 Mbps Ethernet interface 2
7	RS-232 serial interface	Connect to RS-232 devices, e.g., PC etc.
8	GE1	Local management network interface
9	G1	10/100/1000 Mbps Ethernet interface
10	LAN	LAN 10/100 Mbps Ethernet interface

 NOTE

DS-6904UDI provides 4-ch HDMI output interfaces and other interfaces are the same with DS-6908UDI.

● Front Panel of DS-6910/6912/6916UDI

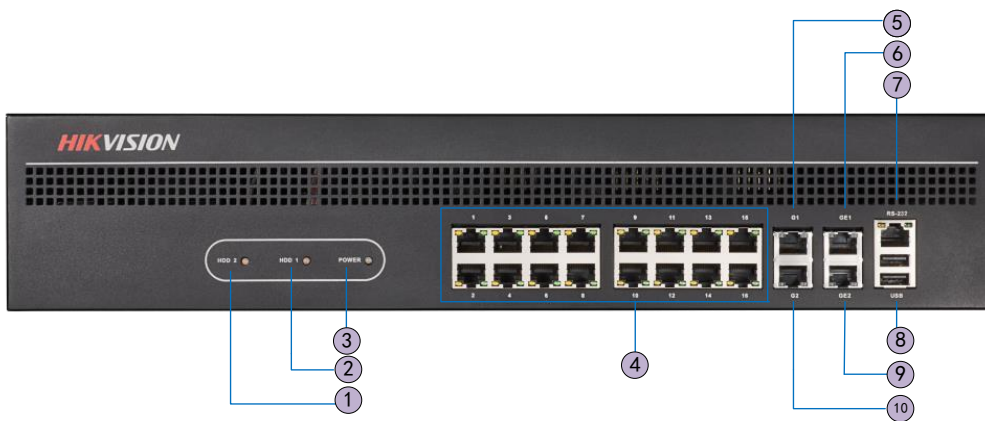

Figure 2-3 Front Panel of DS-6916UDI

Table 2-3 Description of DS-6916UDI Front Panel

	LED Indicator & Interface	Connections
1	HDD1	Hard disk 1 indicator (Reserved)
2	HDD2	Hard disk 2 indicator (Reserved)
3	POWER	Power indicator
4	LAN	10/100 Mbps Ethernet interface
5	G1	10/100/1000 Mbps Ethernet interface
6	GE1	Local management network interface
7	RS-232 serial interface	Connect to RS-232 devices, e.g., PC etc.
8	USB	USB 2.0 interface
9	GE2	Local management network interface 2
10	G2	10/100/1000 Mbps Ethernet interface 2

## 2.2 Rear Panel

- Rear Panel of DS-6901UDI

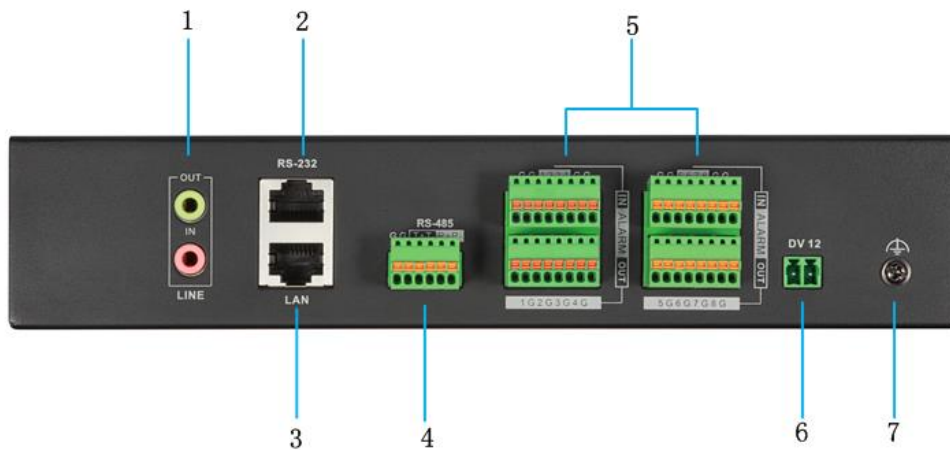



Figure 2-4 Rear Panel of DS-6901UDI

Table 2-5 Description of DS-6901UDI Rear Panel

	Interface	Connections
1	LINE IN/OUT	Two-way audio input/output, 3.5 mm connector
2	RS-232 serial interface	Connect to RS-232 devices, e.g., PC.
3	LAN	10/100/1000 Mbps Ethernet interface

4	RS-485 serial interface	Connect to RS-485 devices, e.g., keyboard.
5	Alarm in	8 alarm inputs
	Alarm out	8 alarm outputs
6	Power supply	12 VDC power input
7		GND

● Rear Panel of DS-6908UDI

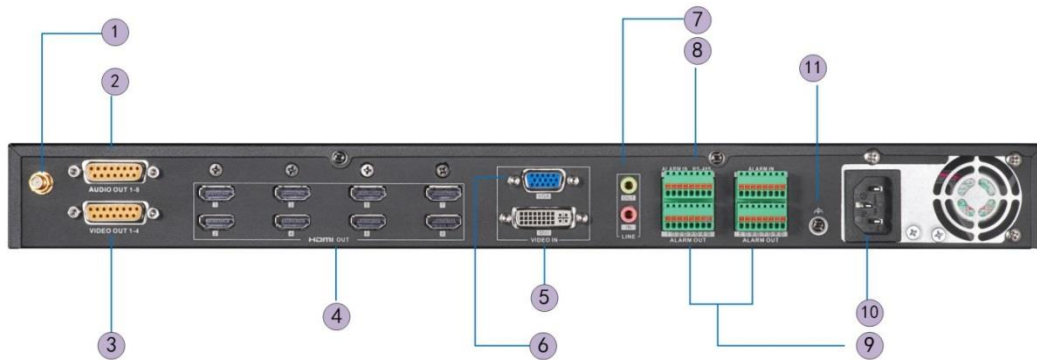



Figure 2-5 Rear Panel of DS-6908UDI

Table 2-6 Description of DS-6908UDI

	Interface	Connections
1	Wi-Fi	For Wi-Fi connection
2	Audio output	BNC connector
3	Video output	BNC connector
4	HDMI video output	HDMI output of decoded video
5	DVI video input	DVI input of decoded video
6	VGA video input	VGA input of decoded video
7	LINE IN/OUT	Two-way audio input/output, 3.5mm connector
8	RS-485 serial interface	Connect to RS-485 devices, e.g., keyboard.
9	Alarm in	8 alarm inputs
	Alarm out	8 alarm outputs
10	Power	Power indicator
11		GND

● Rear Panel of DS-6916UDI

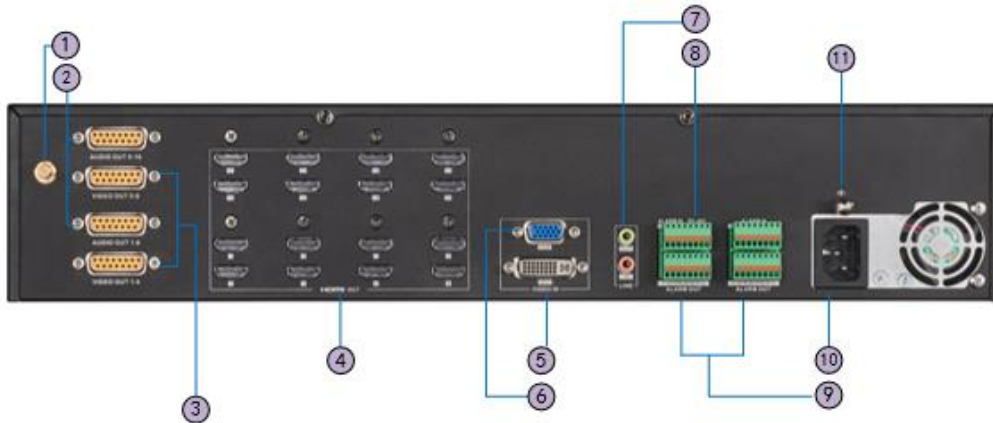



Figure 2-6 Rear Panel of DS-6916UDI

Table 2-7 Description of DS-6916UDI Rear Panel

	Interface	Connections
1	Wi-Fi	For Wi-Fi connection
2	Audio output	BNC connector
3	Video output	BNC connector
4	HDMI video output	HDMI output of decoded video
5	DVI video input	DVI input of decoded video
6	VGA video input	VGA input of decoded video
7	LINE IN/OUT	Two-way audio input/output, 3.5mm connector
8	RS-485 serial interface	Connect to RS-485 devices, e.g., keyboard, etc.
9	Alarm in	8 alarm inputs
	Alarm out	8 alarm outputs
10	Power	Power indicator
11		GND

 NOTE

DS-6910UDI provides 10 HDMI output interfaces, DS-6912UDI provides 12 HDMI output interfaces and other interfaces are the same with DS-6916UDI.

# Chapter 3 Getting Started

## Purpose

You are required to activate the decoder first by setting a strong password for it before you can use the device. And you can configure the basic network parameters.

Activation via Web Browser and Client Software are all supported.



For the first-time user, the default user name of DS-6900UDI is *admin*, and the default IP address is 192.0.0.64.

## 3.1 Activating via SADP Software

SADP software is used for detecting the online device, activating the camera, and resetting the password.

Get the SADP software from the supplied disk or the official website, and install the SADP according to the prompts. Follow the steps to activate the camera.

Step 1 Run the SADP software to search the online devices.

Step 2 Check the device status from the device list, and select the inactive device.

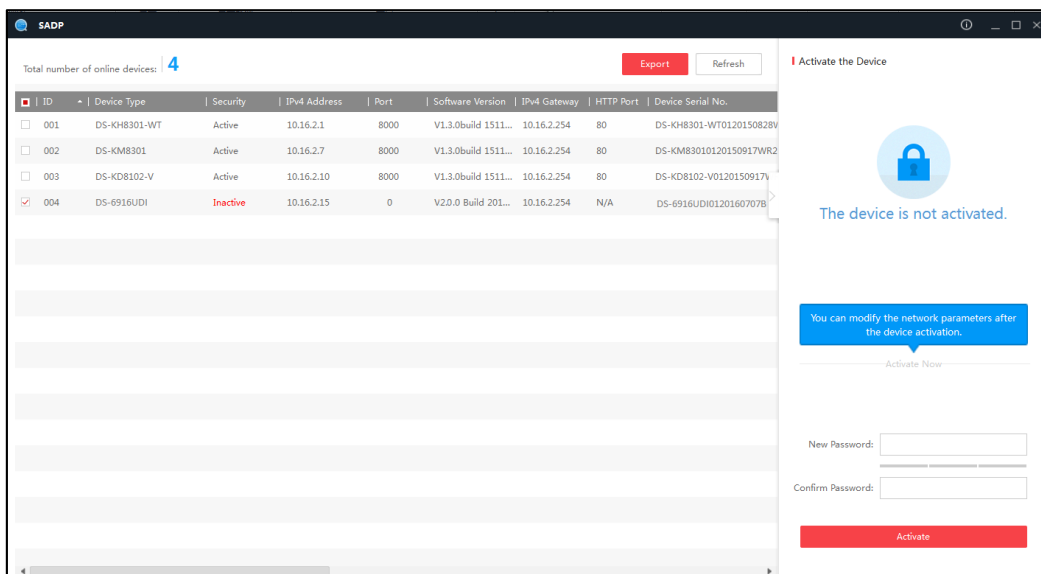

Figure 3-1 SADP Interface

Step 3 Create a password and input it in the password field, and confirm the password.

Step 4 Click **Activate** to activate the device.



**WARNING**

**STRONG PASSWORD RECOMMENDED**—We highly recommend you create a strong password of your own choosing (Using a minimum of 8 characters, including at least three of the following categories: upper case letters, lower case letters, numbers, and special characters.) in order to increase the security of your product. And we recommend you reset your password regularly, especially in the high security system, resetting the password monthly or weekly can better protect your product.

Step 5 Change the device IP address to the same subnet with your computer by either modifying the IP address manually or checking the checkbox of Enable DHCP.

Figure 3-2 Modify the IP Address

Step 6 Input the password and click the **Modify** button to activate your IP address modification.

## 3.2 Activation via Web Browser

Step 1 Power on the decoder, and connect the decoder to the network.

Step 2 Input the IP address into the address bar of the web browser, and click Enter to enter the activation interface.



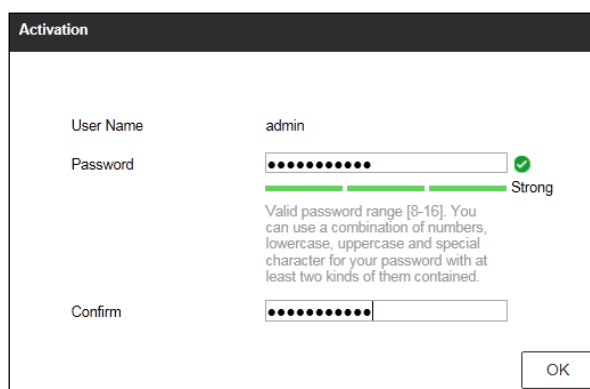

The screenshot shows a window titled "Activation". It contains three input fields: "User Name" with the value "admin", "Password" with a masked field and a green checkmark, and "Confirm" with a masked field. Below the password field is a strength indicator showing a full green bar and the word "Strong". A text box below the strength indicator reads: "Valid password range [8-16]. You can use a combination of numbers, lowercase, uppercase and special character for your password with at least two kinds of them contained." An "OK" button is located at the bottom right of the window.

Figure 3-3 Activation Interface

Step 3 Create a password and input the password into the password field.



**STRONG PASSWORD RECOMMENDED**—We highly recommend you create a strong password of your own choosing (Using a minimum of 8 characters, including at least three of the following categories: upper case letters, lower case letters, numbers, and special characters.) in order to increase the security of your product. And we recommend you reset your password regularly, especially in the high security system, resetting the password monthly or weekly can better protect your product.

---

Step 4 Confirm the password.

Step 5 Click **OK** to save the password and enter the live view interface.

### 3.3 Activation via Client Software

The client software is versatile video management software for multiple kinds of devices.

Get the client software from the supplied disk or the official website, and install the software according to the prompts. Follow the steps to activate the camera.

Step 1 Run the client software and the Video Wall interface pops up, as shown in the figure below.

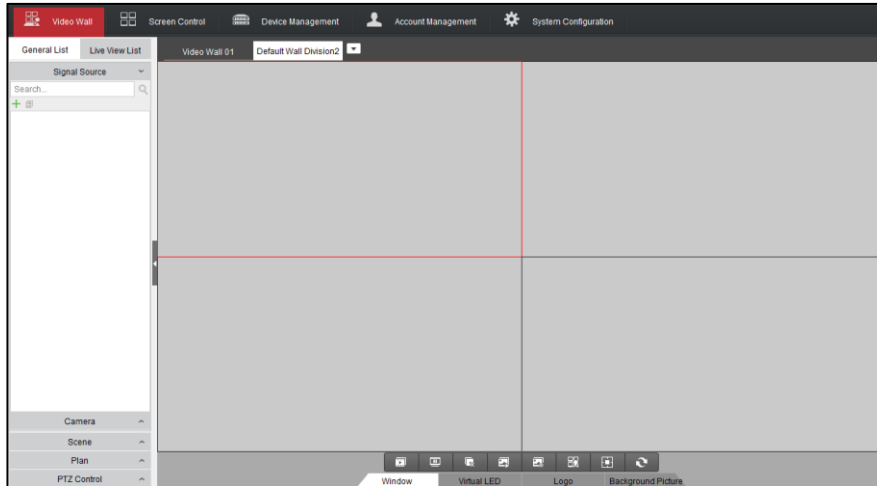

Figure 3-4 Control Panel

Step 2 Click the **Device Management** icon to enter the Device Management interface, as shown in the figure below.

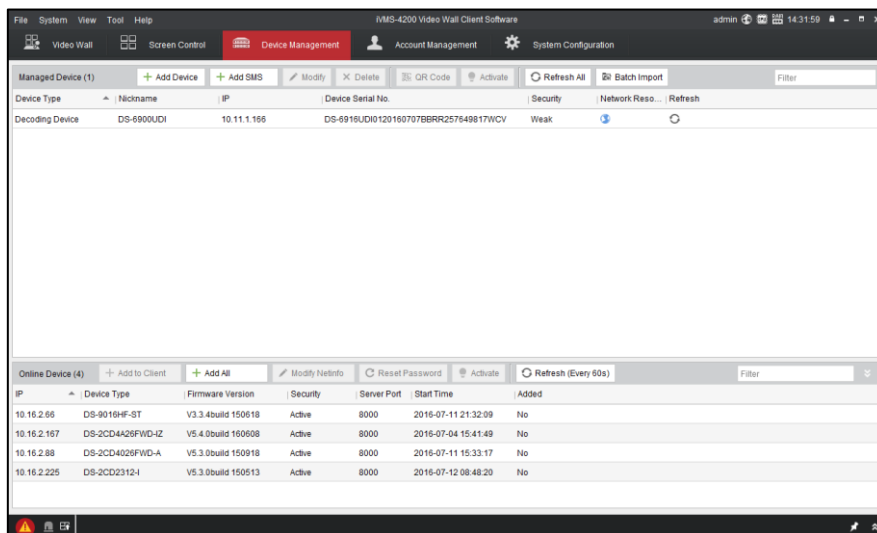

Figure 3-5 Control Panel

Step 3 Check the device status from the device list, and select an inactive device.

Step 4 Click the **Activate** button to pop up the Activation interface.

Step 5 Create a password and input the password in the password field, and confirm the password.



**WARNING**

**STRONG PASSWORD RECOMMENDED**—We highly recommend you create a strong password of your own choosing (Using a minimum of 8 characters, including at least three of the following categories: upper case letters, lower case letters, numbers, and special characters.) in order to increase the security of your product. And we recommend you reset your password regularly, especially in the high security system, resetting the password monthly or weekly can better protect your product.

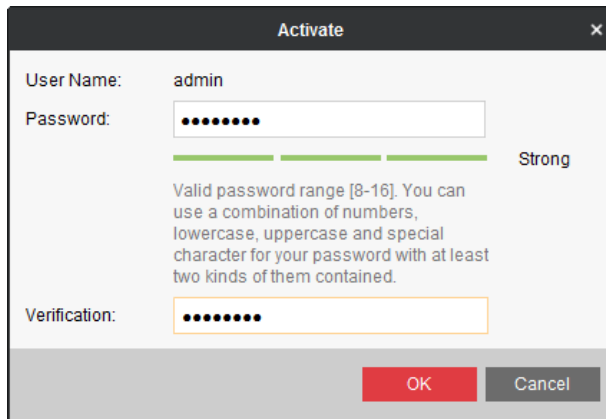

Figure 3-6 Activation Interface (Client Software)

Step 6 Click **OK** button to start activation.

Step 7 Click the **Modify Netinfo** button to pop up the Network Parameter Modification interface, as shown in the figure below.

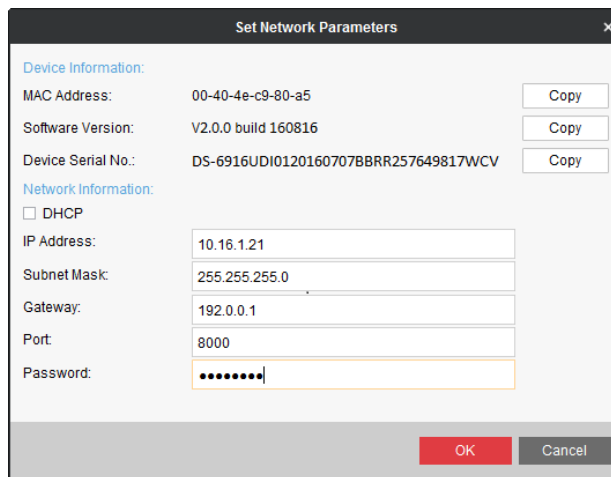

Figure 3-7 Modify the Network Parameters

Step 8 Change the device IP address to the same subnet with your computer by either modifying the IP address manually or checking the **DHCP** checkbox.

Step 9 Input the password to activate your IP address modification.

## Chapter 4 Decoder Configuration and Operation by Web Browser



You shall acknowledge that the use of the product with the Internet access might be under network security risks. For avoidance of any network attacks and information leakage, please strengthen your own protection. If the product does not work properly, contact with your dealer or the nearest service center.

### ***Purpose***

You can configure and operate the device by Web browser or the iVMS-4200 Video Wall Client Software. In this chapter, the operation and management of the decoder by the Web browser is provided.



The tested Web browsers include: IE 8.0+, Chrome 18.0+, Firefox 5.0+, and Safari 5.02+.

Step 1 Open the Web browser and input the IP address of Decoder (e.g., <http://192.168.0.0>).

Step 2 Log in to the device.

A screenshot of a web browser login interface. It features two text input fields: the top one is labeled 'User Name:' and the bottom one is labeled 'Password:'. Below these fields is a prominent red rectangular button with the word 'Login' written in white, centered text.

Figure 4-1 Login Interface

- If the device has not been activated, you need to activate the device first before login.

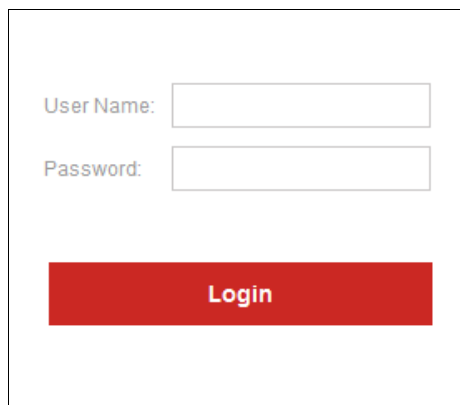
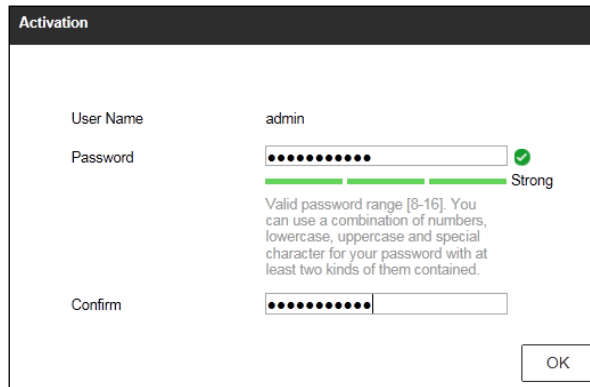

Figure 4-2 Activation Interface

 **WARNING**

**STRONG PASSWORD RECOMMENDED**—We highly recommend you create a strong password of your own choosing (Using a minimum of 8 characters, including at least three of the following categories: upper case letters, lower case letters, numbers, and special characters.) in order to increase the security of your product. And we recommend you reset your password regularly, especially in the high security system, resetting the password monthly or weekly can better protect your product.

- If the device is already activated, input the user name and password in the login interface, and click the **Login** button.

The following interface is shown after successful login.

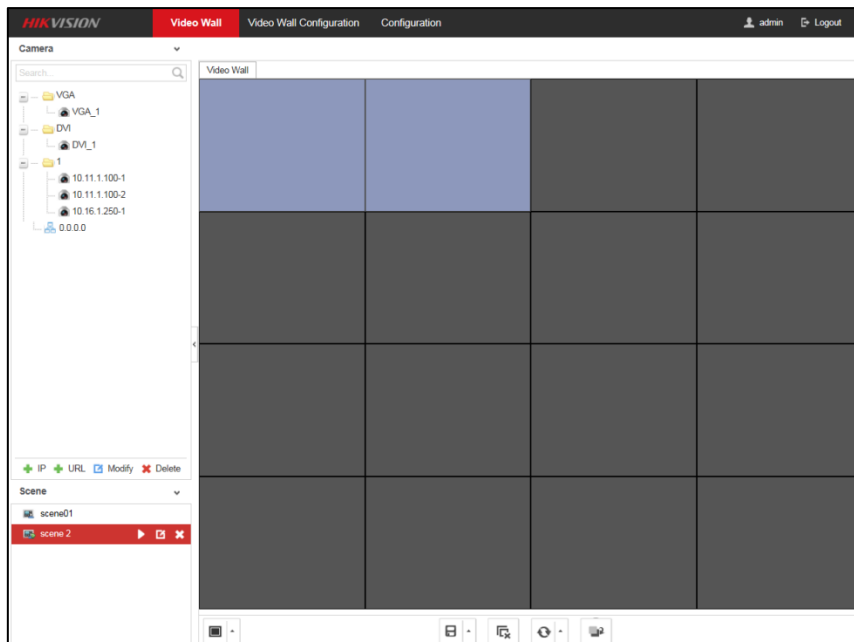

Figure 4-3 Enter Web Page

## 4.1 Decoder Configuration

### 4.1.1 Checking Device Information

**Purpose**

You can check the information of the device in the device information interface, such as the Device Type, Device Serial No., Firmware Version, Decoding Version, Web Version, Plugin Version etc.

Click **Configuration > System > System Settings > Basic Information** to view Device Type, Device Serial No., Firmware Version, DSP Version, etc.



The description about the decoder configuration and operation by web browser below is based on the firmware, decoding, web and plugin version shown in the following figure.

Basic Information	Time Settings	RS-232	RS-485
Device Name	Embedded multiDecoder		
Physical Address	00:40:74:a4:b5:e6		
Device Type	DS-6916UDI		
Device Serial No.	DS-6916UDI0120160707BBRR257649817WCV		
Firmware Version	V2.0.0 build 160912		
Decoding Version	V2.0 build 160830		
Web Version	V4.1.1 build 160830		
Plugin Version	V3.0.5.40		
<input type="button" value="Save"/>			

Figure 4-4 Checking Device Information

### 4.1.2 Configuring Time Settings

**Purpose**

You can set the time for the decoder in the **Time Settings** interface.

Step 1 Click **Configuration > System Settings > Time Settings** to enter the following interface:

Figure 4-5 Configure Time Settings

Step 2 Configure the time synchronization by NTP server or manually.

● **Configuring Time Synchronization by NTP Server**

A Network Time Protocol (NTP) Server can be configured on your device to ensure the accuracy of system date/time.

If the device is connected to a Dynamic Host Configuration Protocol (DHCP) network that has time server properties configured, the camera will synchronize automatically with the time server.

Enable the **NTP** function by selecting the radio button, and configure the following settings:

**NTP Server:** IP address of NTP server.

**NTP Port:** Port of NTP server.

Figure 4-6 Configure Time by NTP

 **NOTE**

If the device is connected to a public network, you should use a NTP server that has a time synchronization function, such as the server at the National Time Center (IP Address: 210.72.145.44). If the device is set up in a more customized network, NTP software can be used to establish a NTP server used for time synchronization.

● **Configuring Time Synchronization Manually**

Enable the **Manual Time Sync.** function by selecting the radio button and then click icon  to set the system time from the pop-up calendar.

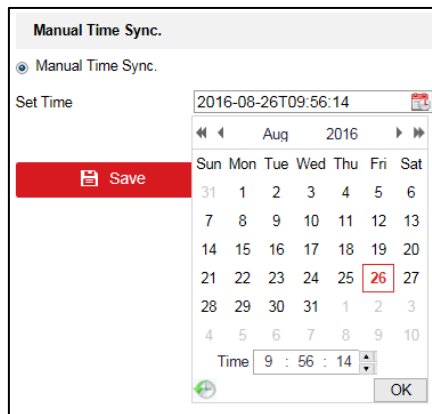

Figure 4-7 Configure Time Manually

Step 3 Select the time zone that is closest to the device’s location from the drop-down list.

Step 4 Click **Save** to save the settings.

### 4.1.3 Configuring RS-485/RS-232 Serial Port

#### Configure RS-232 Parameters

Step 1 Click **Configuration > System Settings > RS-232** to enter the following interface:

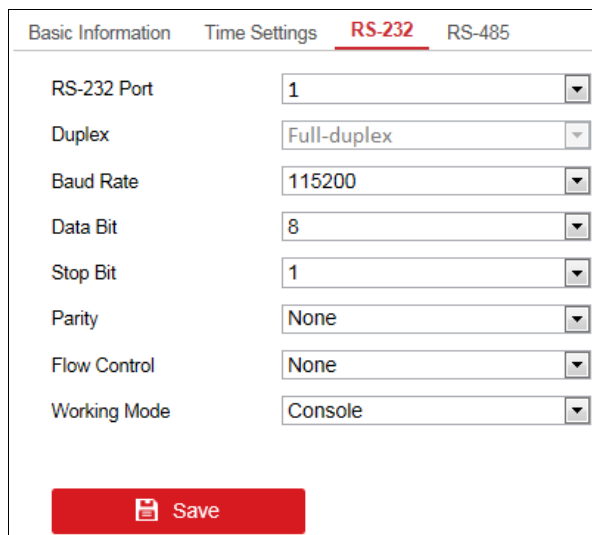

Figure 4-8 Configure RS-232 Settings

Step 2 Configure the RS-232 parameters, including the baud rate, data bit, stop bit and parity type.

Step 3 Select the Operating Mode of RS-232 as Console or Transparent Channel.

**Console:** Use the RS-232 serial port for debugging the decoder.

**Transparent Channel:** Use the RS-232 serial port as the transparent channel.



Step 4 Click **Save** to save the settings.

## Configure RS-485 Parameters

Step 1 Click **Configuration** > **System Settings** > **RS-485** to enter the following interface:

Basic Information	Time Settings	RS-232	<b>RS-485</b>
RS-485 Camera No.			1
Duplex			Half-duplex
Baud Rate			9600
Data Bit			8
Stop Bit			1
Parity			None
Flow Control			None

**Save**

Figure 4-9 Configure RS-485 Settings

Step 2 Configure the RS-485 parameters, including the baud rate, data bit, stop bit and parity type.

Step 3 Click **Save** to save the settings.

## 4.1.4 Configuring Basic Network Settings

### **Purpose**

You can set the network parameters for the decoder in the parameter configuration interface.

Step 1 Click **Configuration** > **Network** > **TCP/IP** to enter the general network settings interface.

TCP/IP	DDNS	Wi-Fi
Select NIC		NIC1
IPv4 Address		10.11.1.166
IPv4 Subnet Mask		255.255.255.0
IPv4 Gateway		10.11.1.254
Preferred DNS Server		0.0.0.0
Alternate DNS Server		0.0.0.0

**Save**

Figure 4-10 Configure Basic Network Settings

Step 2 Set the network parameters, including the NIC, IP Address, Subnet Mask, Gateway, and DNS Server.



The DS-6904/6908/6910/6912/6916UDI provides multiple NICs for selection.

Step 3 Click **Save** to save the settings.

## 4.1.5 Configuring DDNS Settings

### **Purpose**

If your device is set to use PPPoE as its default network connection, you may set Dynamic DNS (DDNS) to be used for network access.

Prior registration with your DDNS Provider is required before configuring the system to use DDNS.

Step 1 Click **Configuration > Network > DDNS** to enter the DDNS Settings interface.

Step 2 Check the **Enable DDNS** checkbox to enable this function.

Step 3 Select **DDNS Type**. Five different DDNS types are selectable: IPServer, DynDNS, PeanutHull, HiDDNS and NO-IP.

- DynDNS

1. Enter **Server Address** for DynDNS (e.g., members.dyndns.org).
2. Enter the **User Name** and **Password** registered in the DynDNS website.
3. In the **Domain** text field, enter the domain obtained from the DynDNS website.
4. Click **Save** to save the settings.

The screenshot shows the DDNS configuration interface. At the top, there are three tabs: TCP/IP, DDNS (which is selected and highlighted in red), and Wi-Fi. Below the tabs, there is a checkbox labeled 'Enable DDNS' which is checked. Underneath, there is a dropdown menu for 'DDNS Type' set to 'DynDNS'. Below that are several text input fields: 'Server Address' containing 'members.dyndns.org', 'Port' containing '2', 'Domain' containing 'test.dyndns.com', 'User Name' containing 'test', 'Password' (masked with dots), and 'Confirm' (masked with dots). Each of these input fields has a green checkmark icon to its right, indicating that the values are valid. At the bottom of the form is a red button with a white floppy disk icon and the text 'Save'.

Figure 4-11 DynDNS Settings

- IPServer

1. Enter server address for IPServer.
2. Click **Save** to save the settings.



For the IP Server, you have to apply a static IP, subnet mask, gateway and primary DNS from the ISP. The **Server Address** should be entered with the static IP address of the PC that runs IP Server software.

Figure 4-12 IP Server Settings

● PeanutHull

1. Enter User Name and Password obtained from the PeanutHull website.
2. Click **Save** to save the settings.

Figure 4-13 PeanutHull Settings

● HiDDNS

1. Enter the **Server Address** of the HiDDNS server: [www.hik-online.com](http://www.hik-online.com).
2. Enter the **Domain** Name of the device. You can register the alias of the device domain name in the HiDDNS server first and then enter the alias to the domain name in the decoder; you can also enter the domain name directly on the decoder to create a new one.



If a new alias of the device domain name is defined in the decoder, it will replace the old one registered on the server.

3. Click **Save** to save the settings.

Figure 4-14 HiDDNS Settings



After having successfully registered the device on the HiDDNS server, you can access your device via Web browser or client software with the Device Domain Name (device name).

## 4.1.6 Configuring Wi-Fi Settings

### **Purpose**

The Wi-Fi can be used as the supplement of the wired network. You can get stream and decode the video on the video wall when Wi-Fi is enabled if no wired network can be accessed.

Step 1 Click **Configuration** > **Network** > **Wi-Fi** to enter the Wi-Fi Settings interface.

**Wireless List**
Search...

No.	SSID	Security Mode	Signal Strength	Connection Status
1	GXL_TEST	WPA2-Personal	-71	Not connected
2	netcore	WPA2-Personal	-74	Not connected
3	qwer	WEP	-83	Not connected
4	admin	WPA2-Personal	-83	Not connected

**Wi-Fi**

Enable Wi-Fi

SSID:

Security Mode:

Authentication:  Open  Shared

Key Length:  64 bit  128 bit  152 bit

Key Type:  HEX  ASCII

Key 1:

Key 2:

Key 3:

Key 4:

Save

Figure 4-15 Wi-Fi Settings

Step 2 You can view the Wireless List on the interface. Click **Search** button to search the available wireless network. The SSID, Security Mode, Signal Strength and Connection Status are shown in the list.



**NOTE**

Up to 20 Wi-Fi can be listed.

Step 3 Select one from the wireless list.

Step 4 Check the checkbox of **Enable Wi-Fi** to enable the selected Wi-Fi.

Step 5 You can view the **Security Mode** and other parameters.

- Not-Encrypted

The Wi-Fi is not encrypted and can be accessed randomly.

**Wi-Fi**

Enable Wi-Fi

SSID:

Security Mode:

Save

Figure 4-16 Wi-Fi Settings (1)

● WEP

1. For the **Authentication** type, open and shared are selectable. With the open system authentication, key authentication is not needed for connecting the Wi-Fi. With the shared system authentication, the key must be matched with the preset access point key.
2. For the **Key Length**, 64 bit, 128 bit and 152 bit are selectable.
3. For the **Key Type**, HEX and ASCII are selectable.
4. Select one **Key** for activation. 4 keys can be selected. Input the key.

The screenshot shows the 'Wi-Fi' settings interface. At the top, there is a header 'Wi-Fi' and a checked checkbox 'Enable Wi-Fi'. Below this, the 'SSID' field contains the text 'qwer'. The 'Security Mode' is set to 'WEP' via a dropdown menu. Under 'Authentication', the 'Open' radio button is selected. For 'Key Length', the '64 bit' radio button is selected. For 'Key Type', the 'HEX' radio button is selected. There are four key input fields labeled 'Key 1' through 'Key 4'. 'Key 1' is selected with a radio button and contains ten black dots. The other three key fields are empty. At the bottom of the form is a red 'Save' button with a floppy disk icon.

Figure 4-17 Wi-Fi Settings (2)

● WPA-Personal

1. For the **Encryption Type**, TKIP and AES are selectable.
2. Input the **Key**.

The screenshot shows the 'Wi-Fi' settings interface. At the top, there is a header 'Wi-Fi' and a checked checkbox 'Enable Wi-Fi'. Below this, the 'SSID' field contains the text 'qwer'. The 'Security Mode' is set to 'WPA-Personal' via a dropdown menu. The 'Encryption Type' is set to 'TKIP' via a dropdown menu. There is one key input field labeled 'Key 1' which is selected with a radio button and contains ten black dots. A green checkmark is visible to the right of the key field. Below the key field, there is a text label: '8 to 63 ASCII characters or 8 to 64 hexadecimal characters'. At the bottom of the form is a red 'Save' button with a floppy disk icon.

Figure 4-18 Wi-Fi Settings (3)

 **NOTE**

8 to 63 ASCII characters or 8 to 64 hexadecimal characters are allowed.

- WPA2-Personal

Refer to the configuration of WPA-Personal for reference.

Step 6 Click **Save** button to save the settings and the following note window pops up. Click **OK** to reboot the device and enter the Wi-Fi mode.

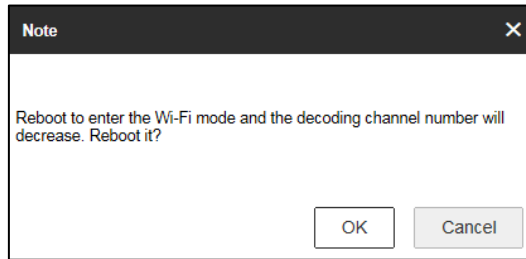

Figure 4-19 Note (1)

Step 7 (Optional) Uncheck the checkbox of **Enable Wi-Fi** and click **Save** to save the settings. The following note window pops up. Click **OK** to reboot the device and exit from the Wi-Fi mode.

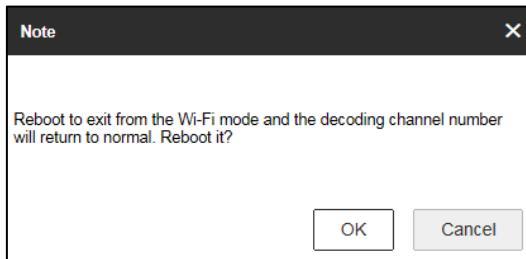

Figure 4-20 Note (2)

 **NOTE**

- If wired network cable is connected to the device when the Wi-Fi is enabled, wired network will be connected by priority. But the decoding capability will conform to the configuration in the Wi-Fi mode.
- In Wi-Fi mode, up to 16 channels can be decoded with up to 1080p resolution of each channel and the maximum bandwidth is 64 Mbps.

## 4.1.7 Configuring Stream Settings

### **Purpose**

The stream configuration refers to the auto stream switch between main stream and sub-stream.

Step 1 Click **Configuration** > **Decoding Configuration** > **Stream Configuration** to enter stream configuration interface.

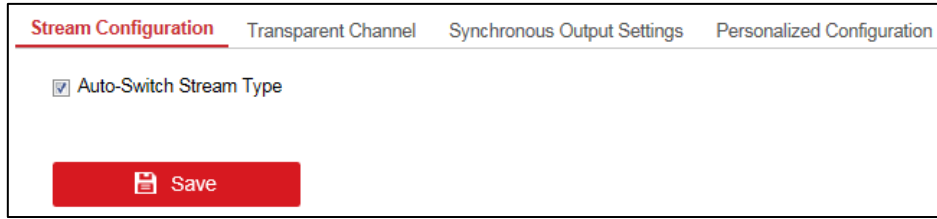

Figure 4-21 Stream Configuration Interface

Step 2 Check the check box of **Auto-Switch Stream Type** to enable auto switch between main stream and sub-stream.

Step 3 Click **Save** button to save the settings.



When a screen is split into more than 16 windows, the main stream will automatically switch to sub-stream to lower the bandwidth.

## 4.1.8 Configuring Transparent Channel

### **Purpose**

The Transparent Channel refers to the transmission channel used for forwarding data between the decoder and the encoder without operating on the data.

Step 1 Click **Configuration > Decoding Configuration > Transparent Channel** to enter transparent channel settings interface.

The screenshot shows a web interface with four tabs: 'Stream Configuration', 'Transparent Channel' (active), 'Synchronous Output Settings', and 'Personalized Configuration'. Below the tabs is a 'Camera List' table with columns: 'No.', 'Local Serial Port', 'Remote Serial Port', 'IP Address', 'Port', and 'Connection Status'. There are 'Modify' and 'Delete' buttons to the right of the table. The table contains 13 rows, all with 'RS-232' in the Local Serial Port column, '0.0.0.0' in the IP Address column, '0' in the Port column, and 'Not connected' in the Connection Status column.

No.	Local Serial Port	Remote Serial Port	IP Address	Port	Connection Status
1	RS-232		0.0.0.0	0	Not connected
2	RS-232		0.0.0.0	0	Not connected
3	RS-232		0.0.0.0	0	Not connected
4	RS-232		0.0.0.0	0	Not connected
5	RS-232		0.0.0.0	0	Not connected
6	RS-232		0.0.0.0	0	Not connected
7	RS-232		0.0.0.0	0	Not connected
8	RS-232		0.0.0.0	0	Not connected
9	RS-232		0.0.0.0	0	Not connected
10	RS-232		0.0.0.0	0	Not connected
11	RS-232		0.0.0.0	0	Not connected
12	RS-232		0.0.0.0	0	Not connected
13	RS-232		0.0.0.0	0	Not connected

Figure 4-22 Transparent Channel Interface

Step 2 Select a transparent channel from the list to configure.

Step 3 Click **Modify** to modify the parameters of the selected transparent channel.



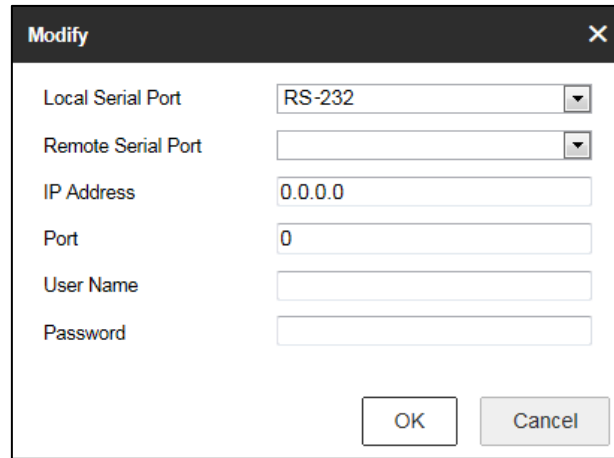

Figure 4-23 Modifying Interface

Step 4 Select the **Local Serial Port** and the **Remote Serial Port** to RS-485 or RS-232.

**Local Serial Port:** The serial port used as the transparent channel by the decoder.

**Remote Serial Port:** The serial port used as the transparent channel by the encoding device.



NOTE

You can click **Delete** to delete the selected channel.

## 4.1.9 Configuring Synchronous Output Settings

### **Purpose**

All video outputs of the device can be configured to be synchronous.

Step 1 Click **Configuration > Decoding Configuration > Synchronous Output Settings** to enter the Synchronous Output Settings interface.

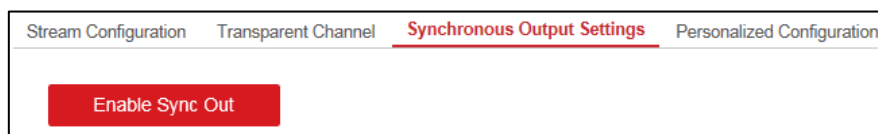

Figure 4-24 Synchronous Output Settings

Step 2 Click the **Enable Sync Out** button to enable the synchronization of all outputs. The following message box pops up.

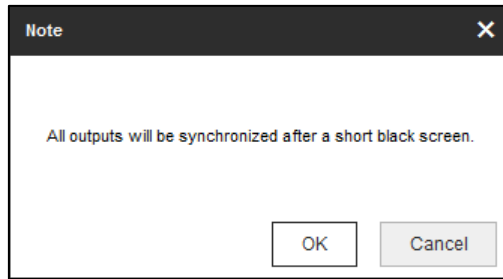

Figure 4-25 Enable Synchronous Output

Step 3 Click **OK** to confirm the settings.

## 4.1.10 Configuring Personalized Settings

### **Purpose**

You can set the stopped decoding image and failed streaming image for the personalized configuration.

Step 1 Click **Configuration > Decoding Configuration > Personalized Configuration** to enter the personalized configuration interface.

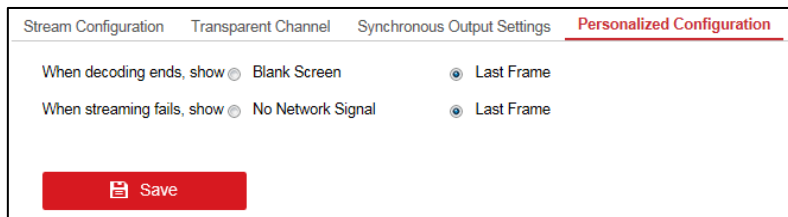

Figure 4-26 Personalized Configuration

Step 2 Select **Blank Screen** or **Last Frame** when decoding ends. If you select **Blank Screen**, the screen will change blank when the decoding ends. If you select **Last Frame**, the screen will show the last frame when the decoding ends.

Step 3 Select **No Network Signal** or **Last Frame** when streaming fails. If you select **No Network Signal**, there shows no network signal when streaming fails. If you select **Last Frame**, the screen will show the last frame when streaming fails.

Step 4 Click **Save** to save the settings.

## 4.1.11 Managing User Account

### **Purpose**

The user accounts can be managed on this interface.

Step 1 Click **Configuration > System > User Management** to enter the user management interface.

User List		Add	Modify	Delete
No.	User Name			
1	admin			
2	pro303			

Figure 4-27 Configure User Account

Step 2 You can add, modify or delete the user account, as well as configure operating permissions for each user account.

**Add** [X]

User Name:  ✓

Admin Password:

Password:  ✓  
Strong

Valid password range [8-16]. You can use a combination of numbers, lowercase, uppercase and special character for your password with at least two kinds of them contained.

Confirm:  ✓

Select All

- Remote Parameter Settings
- Remote Status and Log View
- Remote Upgrade
- Remote Shutdown / Reboot
- Remote Two-way Audio
- Remote Serial Port Control
- Remote Alarm Uploading
- Remote Playback
- Remote PTZ Control

OK Cancel

Figure 4-28 Add User Account and Set Permissions

 **NOTE**

- Up to 32 user accounts can be added including the *admin*.
- For the admin user, only the password can be modified.
- You must input the admin password if you want to modify the user account except the *admin*.

 **WARNING**

**STRONG PASSWORD RECOMMENDED**—We highly recommend you create a strong password of your own choosing (Using a minimum of 8 characters, including at least three of the following categories: upper case letters, lower case letters, numbers, and special characters.) in order to increase the security of your product. And we recommend you reset your password regularly, especially in the high security system, resetting the password monthly or weekly can better protect your product.

## 4.1.12 Importing/Exporting Configuration Files

### **Purpose**

The configuration files of the device can be imported from or exported to local device for backup, which maintains convenient parameters configuration.

Step 1 Click **Configuration > System > Maintenance** to enter the parameters import/export interface.

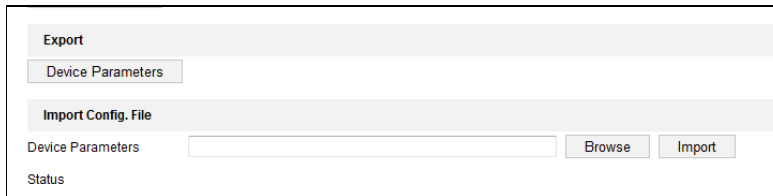

Figure 4-29 Import/Export Configuration File

Step 2 Click **Browse** to select the file from the local directory and then click the **Import** button to import a configuration file. Click **Device Parameters** to export parameters.

## 4.1.13 Maintenance

### **Purpose**

You can click **Configuration > System > Maintenance** to perform Reboot, Upgrade, and Default operations.

### Upgrading the Device

Step 1 Click **Browse** to search the upgrading files.

Step 2 Click **Upgrade** to upgrade it.

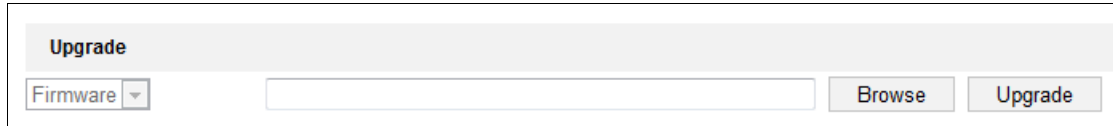

Figure 4-30 Upgrade the Device

 **NOTE**

- When logging in to the device for the first time, install the plug-in according to the prompt on the screen.
- The device will restart after completing the upgrade.

### Restoring the Default Settings

Click **Default** to restore the completed factory settings of the decoder.

Or

Click **Restore** to restore a part of the factory settings of the decoder.

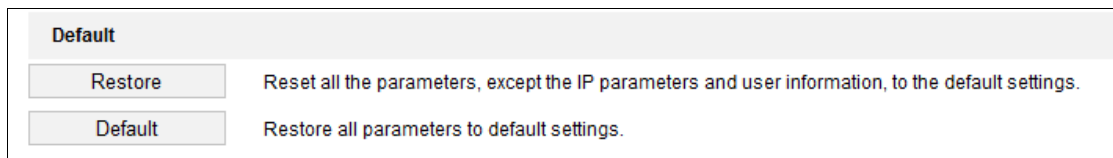

Figure 4-31 Restore Default Settings

### Rebooting the Device

Click **Reboot** to reboot the device.



Figure 4-32 Reboot the Device

## 4.2 Setting Video Wall Layout

### Purpose

To realize the display of the decoded video on the video wall, you must set the Video Wall Configuration first so as to link the video output with video wall.

Step 1 Click **Video Wall Configuration** to enter the corresponding interface.

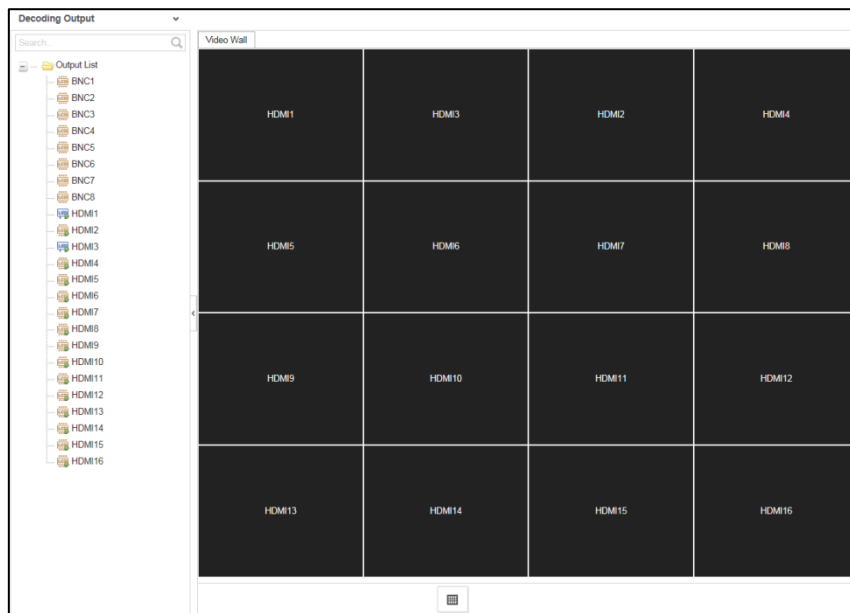



Figure 4-33 Video Wall Configuration

Step 2 You can use the default video wall layout or click  to add a new layout. Input the number of screens in row and column and up to 16 × 20 split screens are available.

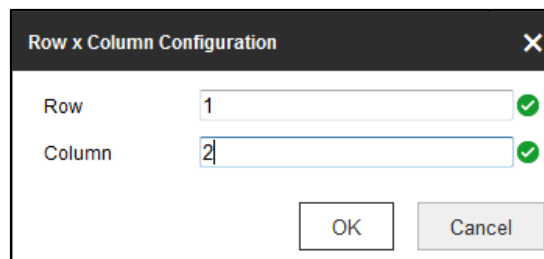



Figure 4-34 Screen Layout Configuration

Step 3 Click **OK** to finish the adding of the video wall information.

Step 4 Drag the output channels from the left-side list to the display screen.

Step 5 Move the cursor to the window, and the icon  automatically appears in the upper-right corner of the window. Click  to close the window.

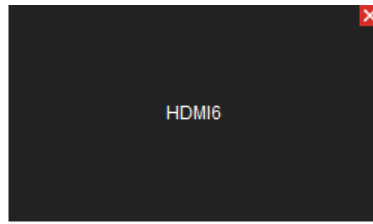

Figure 4-35 Close the Window

## 4.3 Configuring Decoding Output

### **Purpose**

In the output list, there are two kinds of video output signals, respectively BNC and HDMI. You can configure the resolution and output mode.

### Configuring BNC Output

Step 1 Click **Video Wall Configuration** to enter the corresponding interface. Right click one of the BNC signal sources.

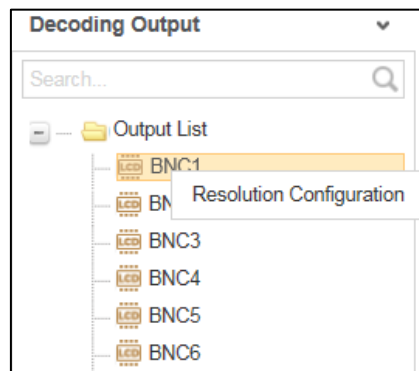

Figure 4-36 BNC Decoding Output

Step 2 Right click one of BNC signal sources and select **Resolution Configuration** to pop up the interface as below.

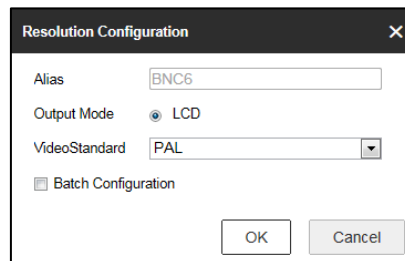

Figure 4-37 Resolution Configuration

Step 3 Select the resolution from the **LCD Resolution** drop-down list. PAL and NTSC are selectable.

Step 4 Check the checkbox of **Batch Configuration** to set the same configuration for other outputs with same signal source.

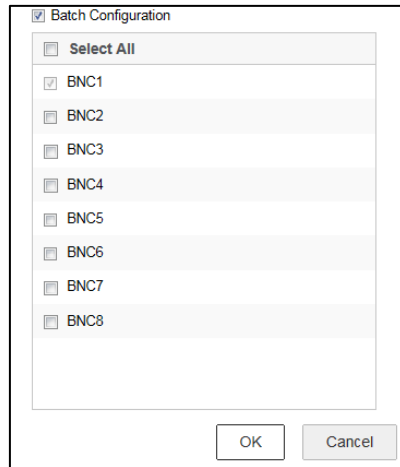

Figure 4-38 Batch Configuration

Step 5 Click **OK** to save the settings.

## Configuring HDMI Output

Step 1 Right click one of the HDMI signal sources.

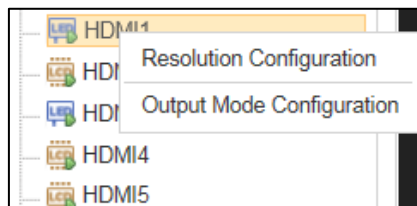

Figure 4-39 HDMI Decoding Output

Step 2 Click **Resolution Configuration** to enter the interface below.

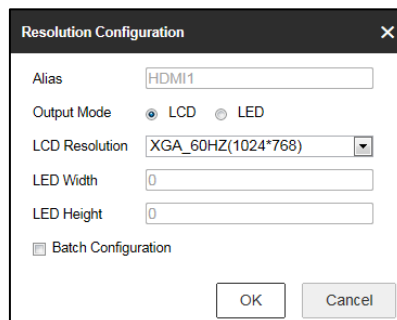

Figure 4-40 Resolution Configuration

Step 3 Select the **Output Mode** and set the corresponding parameters. You can select LCD and LED.

- LCD

1. Select the **Output Mode** to LCD.
1. Select the resolution from the **LCD Resolution** drop-down list.



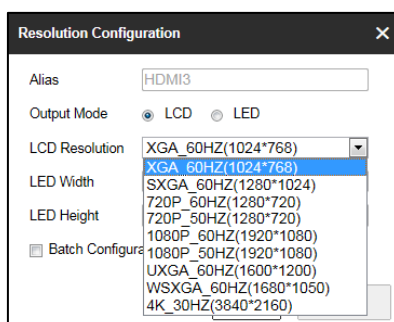

Figure 4-41 Set LCD Resolution

● LED

1. Select the **Output Mode** to LED.
1. Input the **LED Width** and **LED Height** in the corresponding text fields.

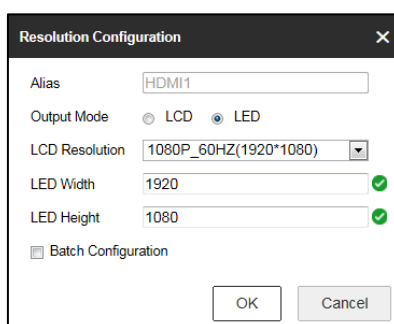

Figure 4-42 Set LED Resolution

**NOTE**

- The value of LED width and height cannot exceed the output resolution you select.
- The supported min. value of LED width × height of HDMI output is 288 × 288 and the max. value is 1920 × 1080.

Step 4 Check the checkbox of **Batch Configuration** to set the same configuration for other outputs with same signal source.

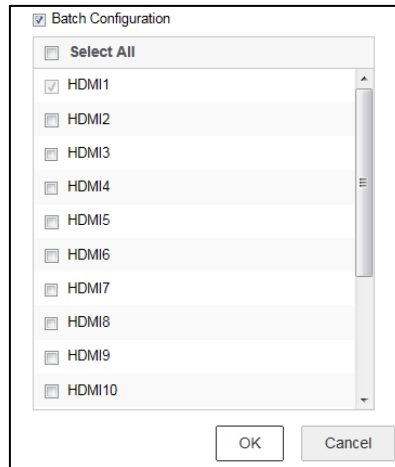

Figure 4-43 Batch Configuration

Step 5 Click **OK** to save the settings.

Step 6 Right click one of the HDMI signal sources and click **Output Mode Configuration** to pop up the interface below.

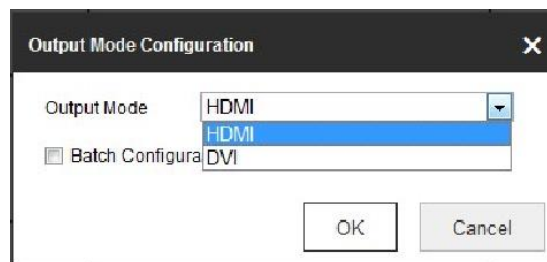

Figure 4-44 Output Mode Configuration

Step 7 Select the output mode to HDMI or DVI.

Step 8 Check the checkbox of **Batch Configuration** to set the same configuration for other HDMI outputs.

Step 9 Click **OK** to save the settings.

## 4.4 Decoding Operation

### **Purpose**

After the video wall layout configuration, the decoding video on the video wall can be realized in this section.

Step 1 Click **Video Wall** to enter the video wall interface.

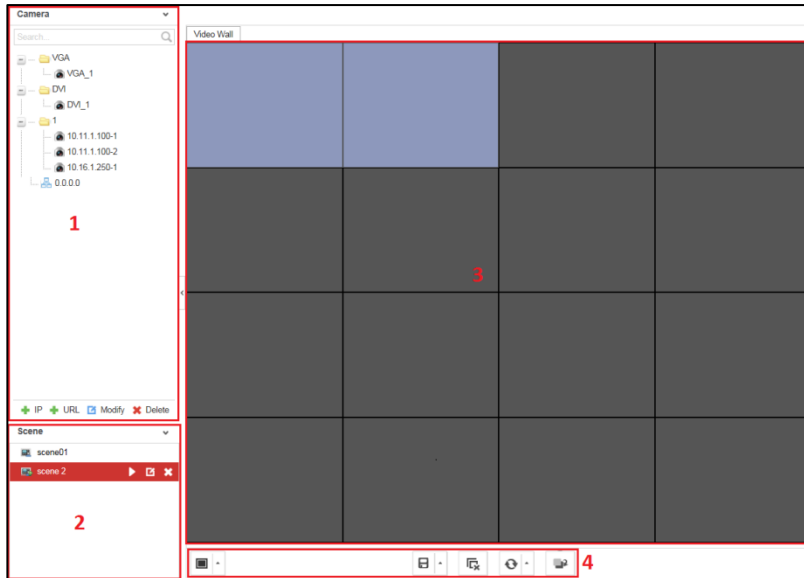







Figure 4-45 Video Wall Interface

Refer to the following figure for the video wall description.

Table 4-1 Description of Video Wall

No.	Description
1	<b>Encoding Device List:</b> The encoding devices added in the Web
2	<b>Scene:</b> The Web supports up to 8 scenes by default, capable of independent scene configuration and fast switching.
3	<b>Video Wall:</b> Video wall operation interface
4	<p><b>Shortcut Toolbar:</b></p> <ul style="list-style-type: none"> <li> Select decoding screen layout</li> <li> Save the scene</li> <li> Delete all windows</li> <li> Refresh all windows</li> <li> If two decoding windows overlap with each other, click the icon to switch the upper window to the bottom.</li> </ul>

### 4.4.1 Adding an Encoding Device

**Purpose**

You can add an encoding device via IP address or URL.

● **Adding an Encoding Device via IP Address**

Step 1 Click **IP** to add encoding devices.

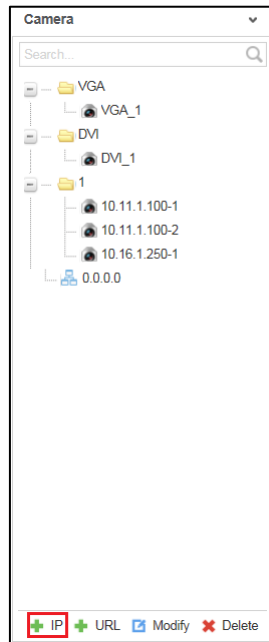

Figure 4-46 Encoding Device List

Step 2 Input **Device Name**, **IP Address**, **Port**, **User Name**, **Password** and **Channel Number** and select the **Transmission Protocol**, **Area Name**, and **Device Manufacturer**. Check the checkbox of **Get Stream by Stream Media** to lower the network load of the device.

The 'Add' dialog box contains the following fields and options:
 

- Device Name: Example 01 ✓
- IP Address: 192.1.1.64 ✓
- Port: 80 ✓
- User Name: admin ✓
- Password: ••••• ✓
- Transmission Protocol: TCP
- Stream Type: Main Stream
- Area Name: 1 +
- Device Manufacturer: ONVIF
- Channel Number: (empty)
- Get Stream by Streammedia
- Streammedia IP Address: (empty)
- Port: (empty)
- Transmission Protocol: TCP

 At the bottom right, there are 'Next' and 'Cancel' buttons.

Figure 4-47 Add Device via IP Address

Step 3 (Optional) You can also click **+** to add a new area and click **Save** to save the area.

Step 4 Click **Next** to select the channel. The channel(s) displayed here depend(s) on the **Channel Number** you input on the previous page.

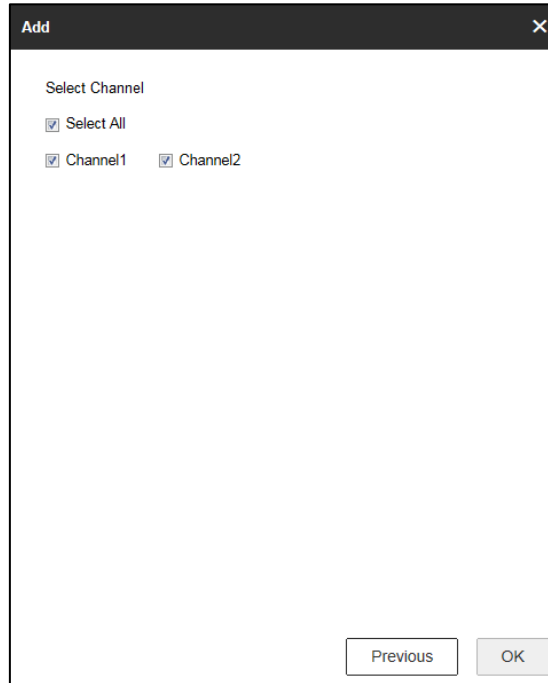

Figure 4-48 Select the Channel

Step 5 Click **OK** to save the settings and add the device.

● **Adding an Encoding Device via URL**

Step 1 Click **URL** to add encoding devices.

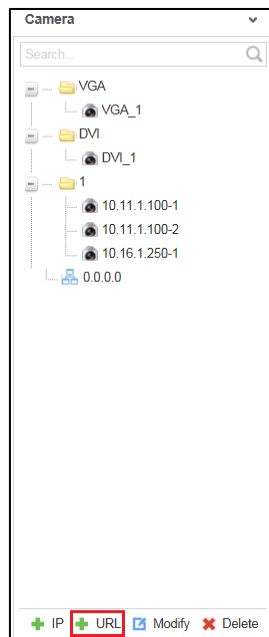

Figure 4-49 Encoding Device List

Step 2 Input the **Device Name** and **URL**. Select the **Area Name** from the dropdown list or click **+** to add a new area.

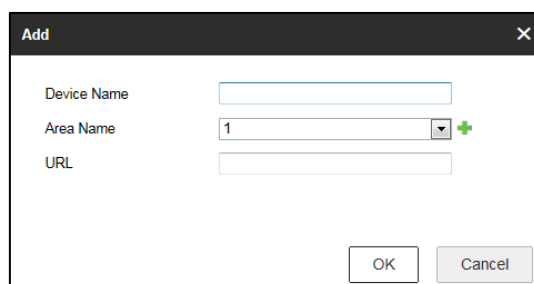

Figure 4-50 Add Device via URL

Step 3 Click **OK** to save the settings.

## 4.4.2 Modifying the Area and Added Encoding Device

Step 1 Select one area or one encoding device, and click **Modify** to modify corresponding parameters.

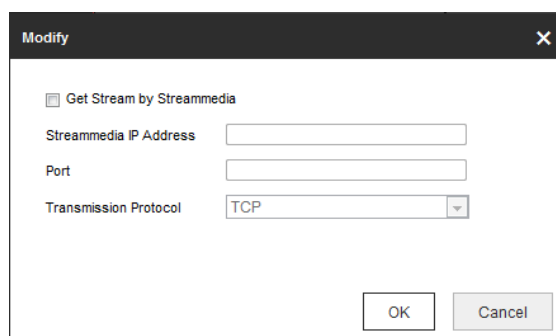

Figure 4-51 Modify Area

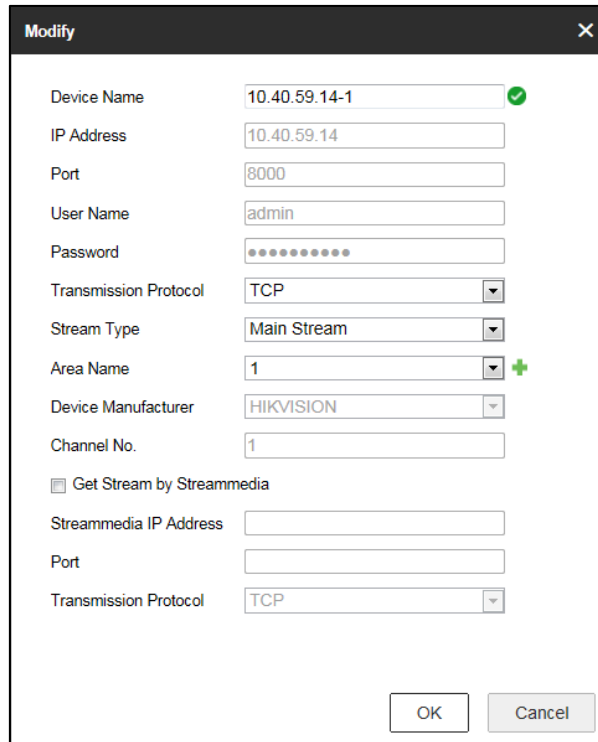

Figure 4-52 Modify Encoding Device

Step 2 Click **OK** to save the new settings.

### 4.4.3 Deleting the Area or Added Encoding Device

Step 1 Select one area or one encoding device and click **Delete** to pop up the note interface below.

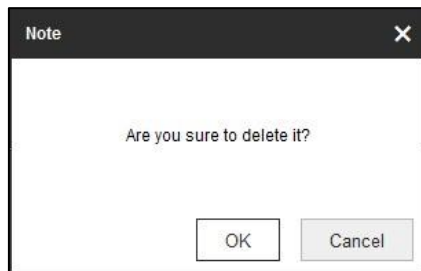

Figure 4-53 Deleting Note

Step 2 Click **OK** to delete it.

### 4.4.4 Decoding on the Video Wall

#### **Purpose**

You can decode the channels from the encoding device list on the video wall by dragging the channel directly or opening window via coordinate.

## Dragging the Channel to the Video Wall

Step 1 Drag the channel from the left side list to realize the decoding in the selected window. You can also drag an area file to the video wall to decode the added encoding devices in the area file on the video wall.

 **NOTE**

- You cannot drag an area file to the video wall across the LCD and LED outputs.
- If there are more than 3 encoding devices in an area, when you drag the area file to the video wall, the note pops up to remind you that no more window can be opened or the total area of layers in single-screen has reached the limit. Only the first 3 encoding devices in the area file can be decoded on the video wall.

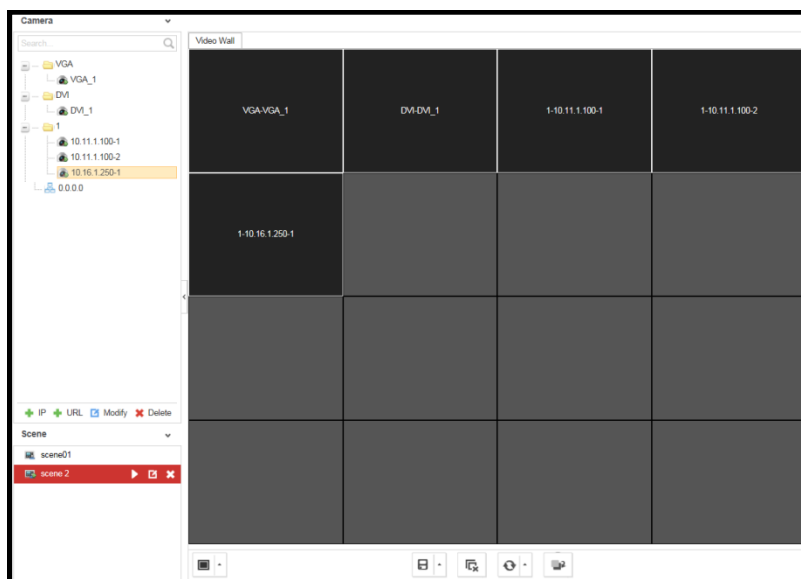

Figure 4-54 Decode the Video on the Wall

Step 2 Select one decoding window and click  to set the decoding screen layout with 1/4/6/8/9/12/16/25/36 window division modes are available.

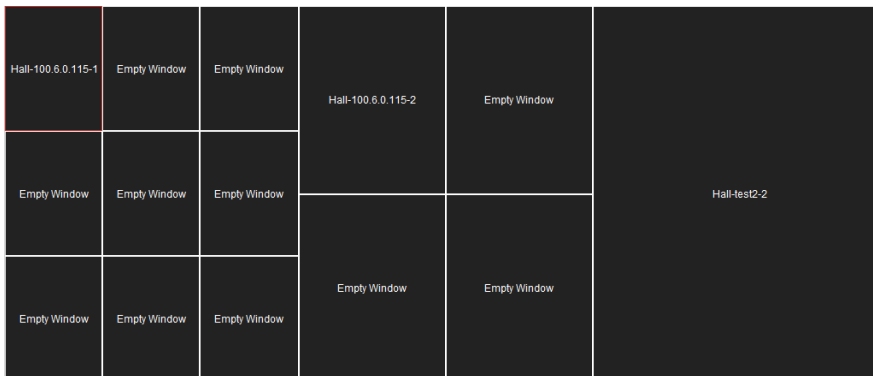

Figure 4-55 Window Division

Step 3 Right click the selected window and the following interface pops up.



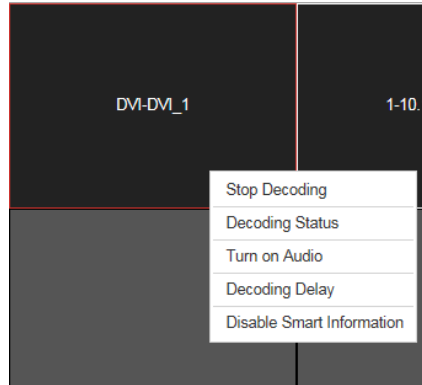

Figure 4-56 Decoding Channel Interface

● **Stop Decoding**

Click the button to stop decoding.

● **Decoding Status**

1. Click the button to enter the decoding status interface.
2. View the decoding status.

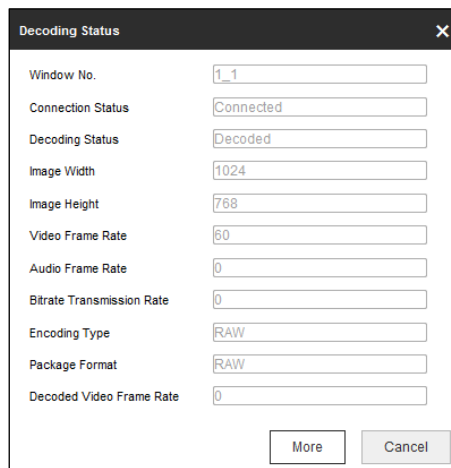

Figure 4-57 Decoding Status

3. Click **More** to check the decoding information of each channel.

Window...	Connection Status	Decoding Status	Image Width	Image Height	Video Frame Rate	Audio Frame Rate	Bitrate Transmission...	Encoding Type	Package Format	Decoded Video Fram...
1_1	Connected	Decoded	1280	720	59	0	0	RAW	RAW	10864
2_1	Connected	Decoded	1280	720	59	0	0	RAW	RAW	10446
3_1	Not connected	Not decoded	0	0	0	0	0	UNKNOWN	UNKNOWN	0
4_1	Not connected	Not decoded	0	0	0	0	0	UNKNOWN	UNKNOWN	0

Figure 4-58 Check More Decoding Status Information

● **Turn on Audio**

1. Click the button to enter the interface below.



Figure 4-59 Turn on Audio

2. Select from the dropdown list to enable the audio in the corresponding window.
3. Click **OK** to save the settings.

● **Decoding Delay**

1. Click the button to enter the decoding delay interface.
2. Select the type of decoding delay. The default mode is the same with medium real time and fluency.

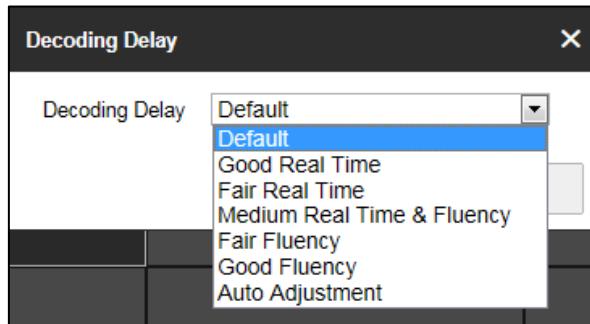

Figure 4-60 Decoding Delay

3. Click **OK** to save the settings.

● **Enable Smart Information**

1. Click the button to enable smart information.
2. (Optional) Click **Disable Smart Information** to disable the function.



NOTE

For the normal IP camera, the smart information refers to the VCA information. For the thermal network camera, the smart information refers to the VCA and the temperature, dynamic fire source detection and ship detection information.

## Opening Window via Coordinate

Step 1 Select one encoding device and right click it to pop up the interface below.

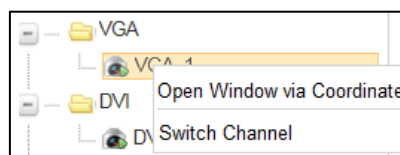

Figure 4-61 Right-Click Menu

Step 2 Click **Open Window via Coordinate** to enter the interface below.

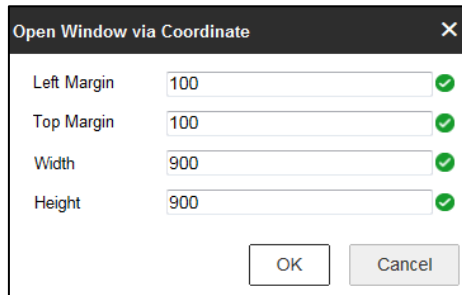

Figure 4-62 Open Window via Coordinate

Step 3 Input the **Left Margin**, **Right Margin**, **Width** and **Height** in the corresponding text fields.

Step 4 Click **OK** to save the settings and the opened window will be displayed on the video wall.

### 4.4.5 Switching Encoding Channel

**Purpose**

You can switch the encoding channel to display on the selected decoding window.

Step 1 Select a decoding window and select an encoding channel from the left side list.

Step 2 Click **Switch Channel** from the right-click menu to switch the selected channel to the decoding window.

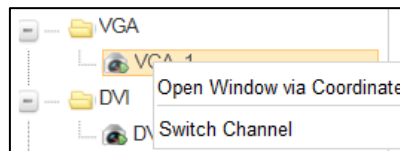

Figure 4-63 Right-Click Menu

### 4.4.6 Configuring Auto-Switch of Cameras

**Purpose**

You can enable auto-switch of the added cameras in one area.

Step 1 Select a camera area and click **Start Auto-Switch** from the right-click menu.

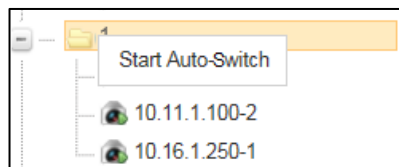

Figure 4-64 Right-Click Menu

Step 2 On the Start Auto-Switch interface, input the **Interval** for auto-switch.



Figure 4-65 Start Auto-Switch

Step 3 Click **OK** to save the settings.

## 4.4.7 Window Roaming

Step 1 Drag one camera from the left side list to the video wall layout to enable decoding in the corresponding window automatically.

Step 2 Drag the decoding window randomly to realize the window roaming on the video wall.



Figure 4-66 Window Roaming

Step 3 Select one of the roaming windows, and click  to realize window division in the selected roaming window with 1/4/6/8/9/12/16/25/36 available.

Step 4 (Optional) Generally the selected window is at top by default. Click  to place the selected window at bottom.

### NOTE

- Roaming and fluent video cannot be realized in the window with the signal output via BNC interfaces.
- The roaming window cannot cross the output window of different resolution. For example, you cannot move the roaming window across the LCD and LED window.

## 4.4.8 Setting Scene

### **Purpose**

Different video wall layouts can be saved as different scenes and up to 8 scenes can be added. You can easily view the required live videos on the video wall by calling the scene.

Step 1 In the Video Wall interface drag the channel from the left side list to realize the decoding in the selected window.

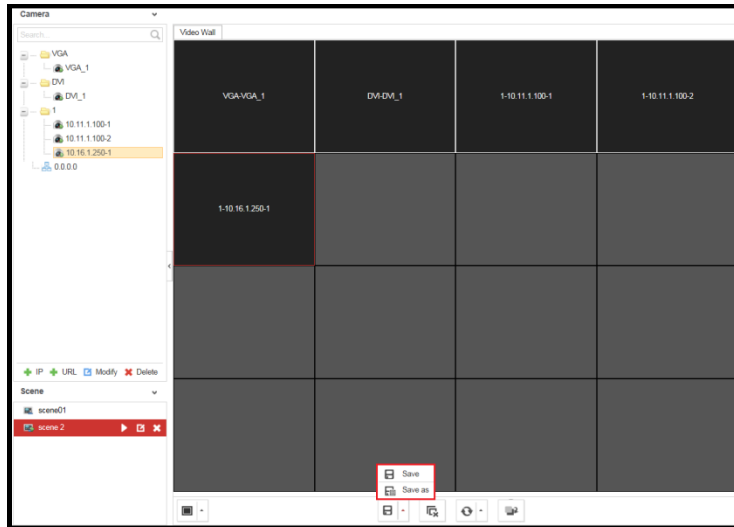

Figure 4-67 Save the Scene

Step 2 Click **Save** to save the scene directly or click **Save as** to pop up the following dialog box.

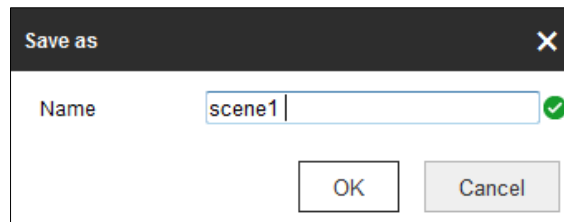

Figure 4-68 Save as Interface

Step 3 Input the **Name** and click **OK** to save the scene.

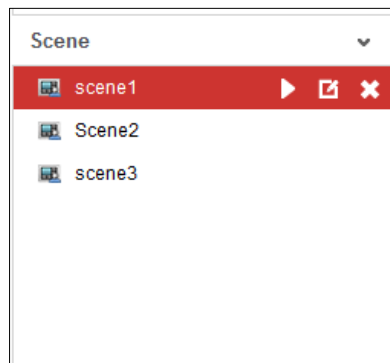





Figure 4-69 Scene List

Step 4 Select one of the scenes you have configured. Click  to call the scene.

Step 5 (Optional) You can also click  to rename the scene, or click  to delete the scene.

# Chapter 5 Decoder Configuration and Operation by Client Software

Run the disk of iVMS-4200 Video Wall Client Software, and double click the icon to install it in your PC. In this chapter, the basic procedure of operating the decoder by the software is described and the description is based on the video wall client software version shown in the following figure.



Figure 5-1 Video Wall Client Software Information

The following figure shows the main interface after accessing to the software.

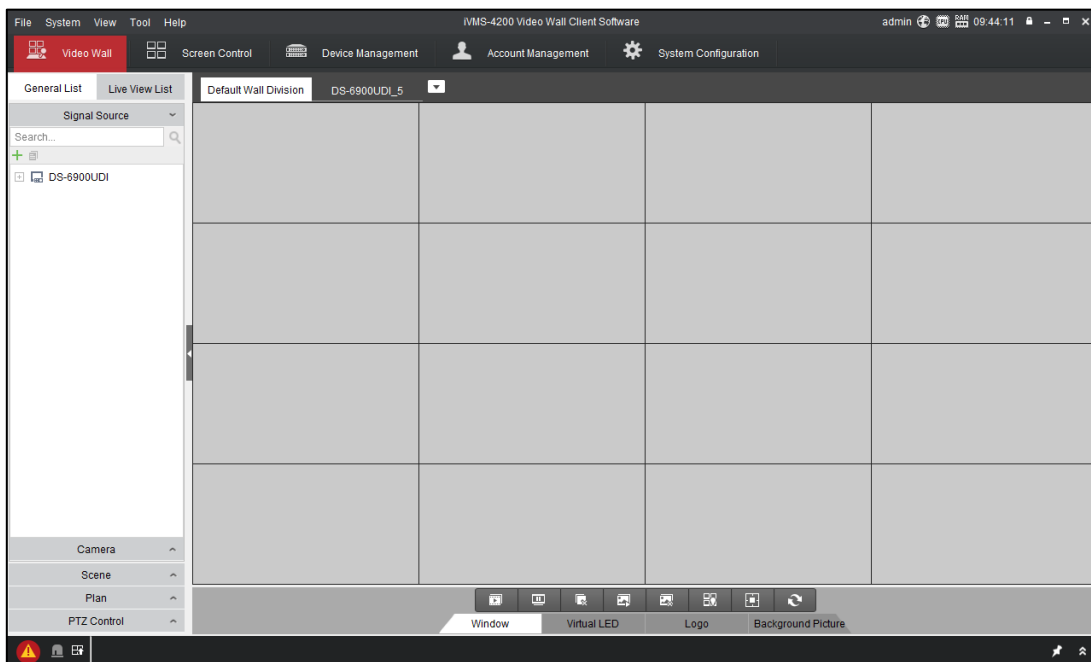









Figure 5-2 Main Interface

Refer to the following table for the description of the decoding toolbar on the bottom of the main interface.

Table 5-1 Decoding Toolbar

Icon	Name	Description
	Start/Stop Live View	Start/Stop live view of all the windows.
	Start/Stop All Decoding	Start/Stop decoding all signal sources and cameras.
	Close All Windows	Close all the windows displayed on the video wall.
	Start All VCA Decoding	Start VCA decoding for all live view signals. Once started, the VCA information can be viewed in live view.
	Stop All VCA Decoding	Stop VCA decoding for all live view signals.
	Open Window	Draw a window according to your need. The size and position of the window are adjustable.
	Open Window via Coordinate	Open a window by inputting X-coordinate, Y-coordinate, width and height.
	Refresh	Refresh the video wall status.

 **NOTE**

The software is capable of many functions for controlling and managing many devices. In this manual, only the operation related to the decoder is introduced.

## 5.1 Adding an Encoding/Decoding Device

Step 1 Click **Device Management** tab to enter the Device Management interface.

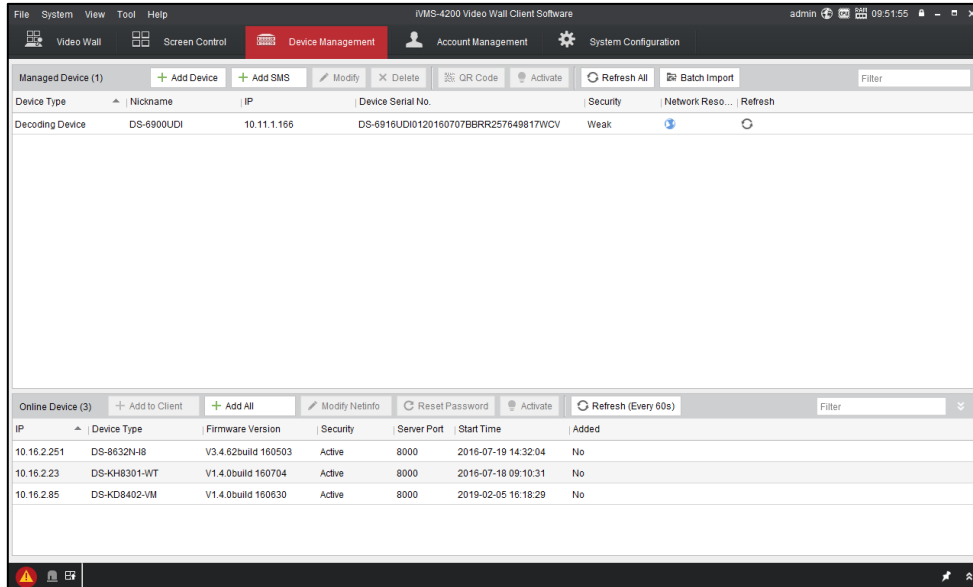

Figure 5-3 Device Management Interface

Step 2 Click **Add Device** and you can add device manually by means of IP address/domain, IP segment and HiDDNS.

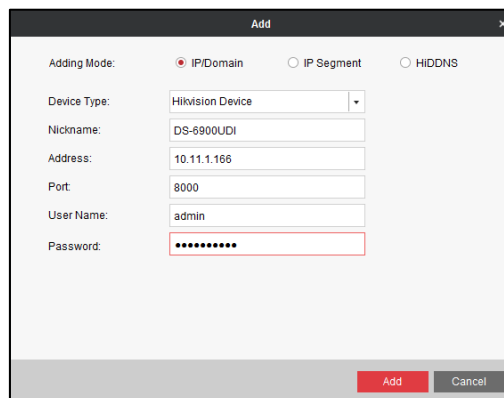

Figure 5-4 Add Device by IP/Domain

Step 3 You can add device by detecting the online devices. The active online decoding devices in the same local subnet with the software are displayed on the list. Select the decoder and click **Add to Client** to add the decoder.

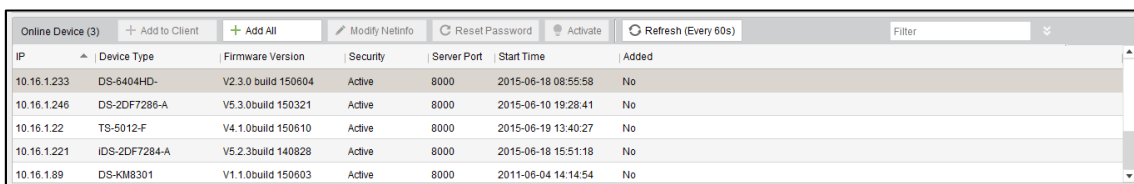

Figure 5-5 Add Device by Detecting the Online Device

The successfully added encoding/decoding device can be viewed in the list.



Managed Device (2)						
<span style="float: right;"> <a href="#">+ Add Device</a> <a href="#">+ Add SMS</a> <a href="#">Modify</a> <a href="#">X Delete</a> <a href="#">QR Code</a> <a href="#">Activate</a> <a href="#">Refresh All</a> <a href="#">Batch Import</a> <input type="text" value="Filter"/> </span>						
Device Type	Nickname	IP	Device Serial No.	Security	Network Reso...	Refresh
Decoding Device	DS-6900UDI	10.11.1.166	DS-6916UDI0120160707BBRR257649817WCV	Weak		
Encoding Device	IP Dome	10.16.1.250	20141119CCWR490340679B	Strong		

Figure 5-6 List of Added Devices

## 5.2 Configuring Video Wall Settings

### 5.2.1 Configuring Video Wall Layout

#### Adding a Video Wall

Step 1 Click **Video Wall** tab to enter the Video Wall interface.

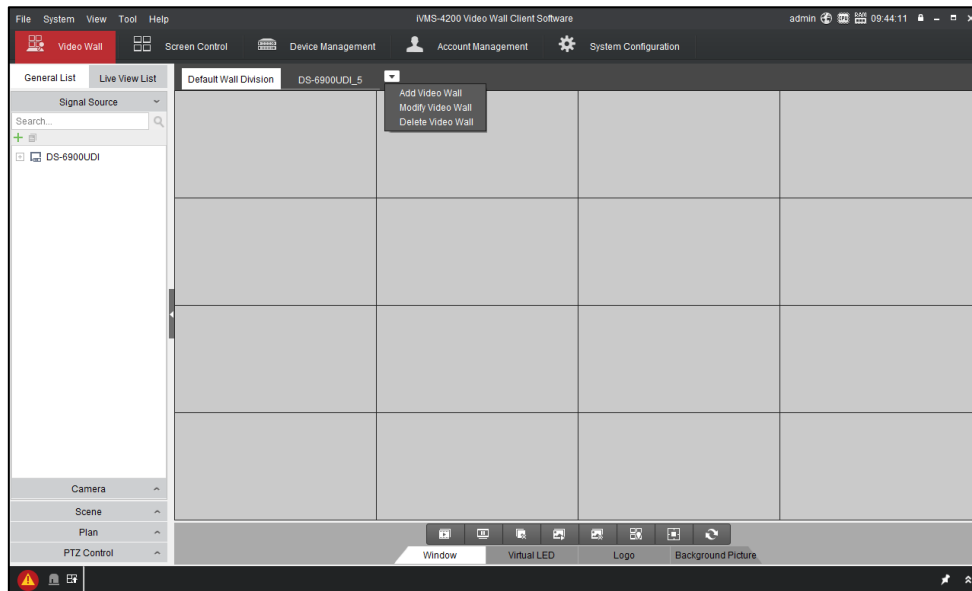

Figure 5-7 Video Wall Interface

Step 2 You can use the default video wall layout or click and select **Add Video Wall** to enter the Add Video Wall interface.



**NOTE**

You can modify the default video wall, but not allowed to delete it.

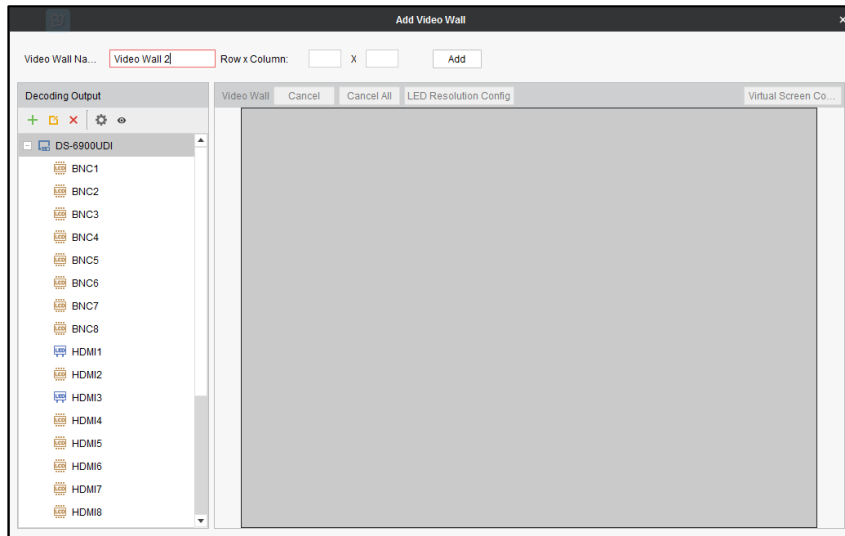

Figure 5-8 Add Video Wall

Step 3 Input the **Video Wall Name**, and the number of windows in row and column text fields.

Step 4 Click **Add** to add the video wall.



**NOTE**

- Up to 5 video walls can be added to the client software.
- The range of the row number is between 1 and 16, and column number between 1 and 20.

Step 5 Drag the output channels from the left side list to link the decoding output to the video wall.

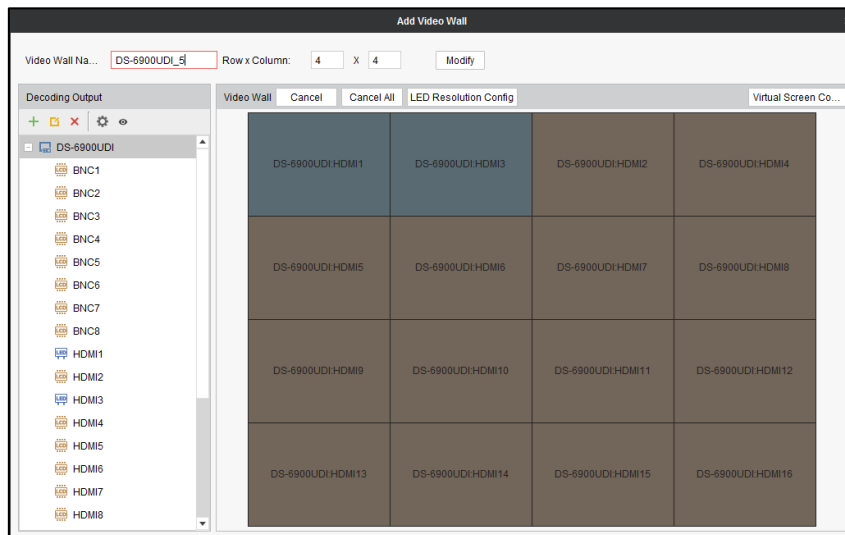

Figure 5-9 Link Decoding Output to Video Wall

Step 6 (Optional) You can select a linked display window and click **Cancel** to cancel the linkage, or click **Cancel All** to cancel all the linked windows.

## Modifying a Video Wall

Click **Modify Video Wall** to edit current video wall's layout, name and decoding outputs.

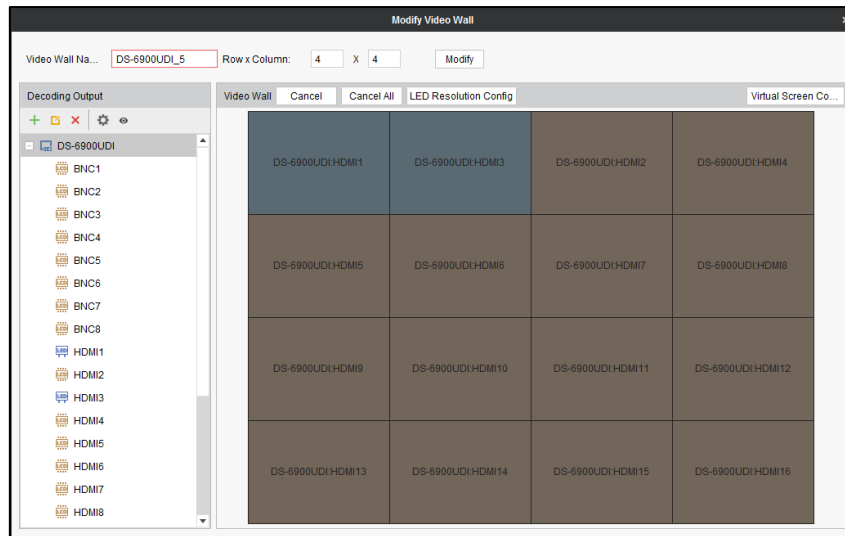

Figure 5-10 Modify Video Wall

## Deleting a Video Wall

Select **Delete Video Wall** and the information dialog box pops up. Click **OK** to delete the selected video wall.

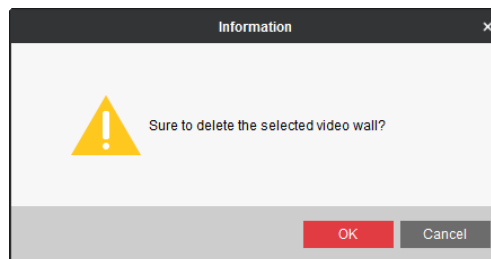



Figure 5-11 Delete Video Wall

## 5.2.2 Configuring Decoding Output

### **Purpose**

You can set the output type and resolution of BNC and HDMI decoding outputs on the Add/Modify Video Wall interface.

### Configuring BNC Output

Step 1 On the Add/Modify Video Wall interface, select a BNC decoding output and click  to enter the Edit Output interface.

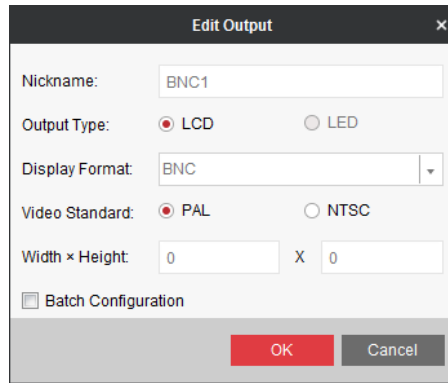

Figure 5-12 Edit BNC Output

Step 2 Select the **Output Type** and set the corresponding parameters. Only LCD output type can be configured.

Step 3 Select the **Video Standard**. PAL and NTSC are selectable.

Step 4 Check the checkbox of **Batch Configuration** to set the same configuration for other outputs with same signal source.

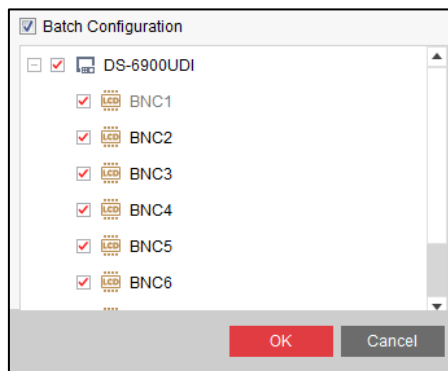



Figure 5-13 Batch Configuration

Step 5 Click **OK** to save the settings.

## Configuring HDMI Output

Step 1 On the Add/Modify Video Wall interface, select a HDMI decoding output and click  to enter the Edit Output interface.

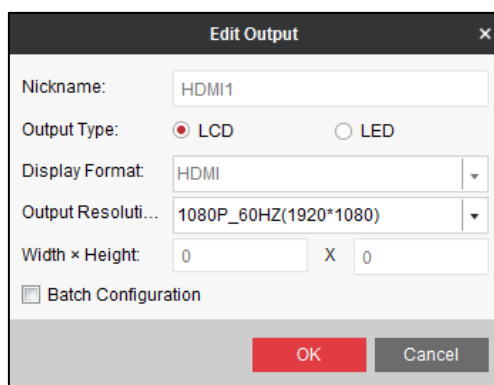

Figure 5-14 Edit HDMI Output

Step 2 Select the **Output Type** and set the corresponding parameters. You can select LCD and LED.

- LCD
  1. Select the **Output Type** to LCD.
  2. Select the **Output Resolution** from the dropdown list.
- LED
  1. Select the **Output Type** to LED.
  2. Select the **Output Resolution** from the dropdown list.
  3. Input the **Width x Height** in the corresponding text fields.

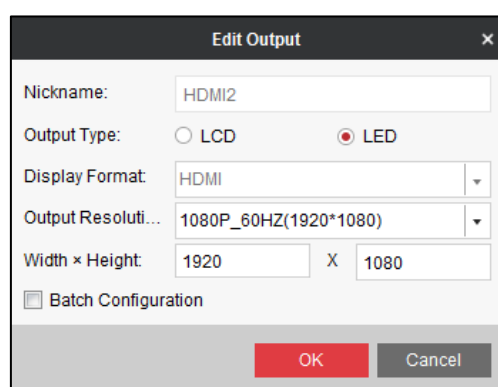

Figure 5-15 Set LED Resolution

 **NOTE**

- The value of LED width and height cannot exceed the output resolution you select.
- The supported min. value of LED width x height of HDMI output is 288 x 288 and the max. value is 1920 x 1080.

Step 3 Check the checkbox of **Batch Configuration** to set the same configuration for other outputs with same signal source.

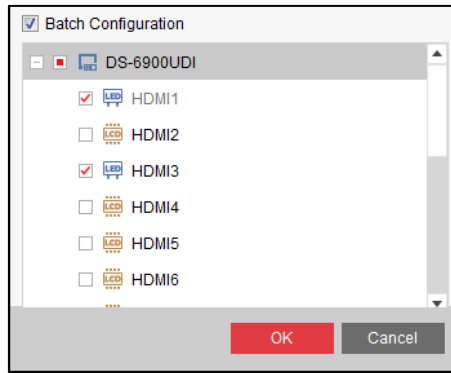

Figure 5-16 Batch Configuration

Step 4 Click **OK** to save the settings.

You can also modify the LED resolution by selecting the LED area and click **LED Resolution Config** to input the **LED Resolution** in the text fields.

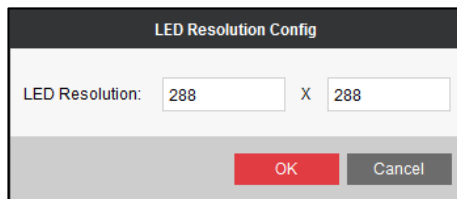



Figure 5-17 Configure LED Resolution

### 5.2.3 Configuring General Parameters of Video Wall

#### **Purpose**

You can configure what the screen show when decoding ends and streaming fails, enable auto-switch of sub-stream, and set the LED window display mode on the Add/Modify Video Wall interface.

Step 1 On the Add/Modify Video Wall interface, select the added decoder and click  to enter the General Parameters Configuration of Video Wall interface.

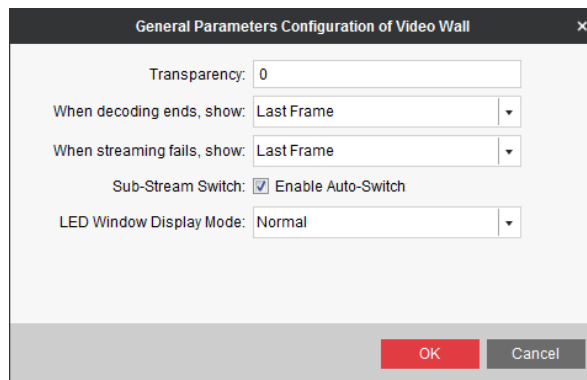

Figure 5-18 General Parameters Configuration of Video Wall

Step 2 Input the **Transparency** (0 to 100 available) to set the transparency of the video wall.

Step 3 Select **Blank Screen** or **Last Frame** when decoding ends. If you select **Blank Screen**, the screen will change blank when the decoding ends. If you select **Last Frame**, the screen will show the last frame when the decoding ends.

Step 4 Select **No Signal** or **Last Frame** when streaming fails. If you select **No Signal**, there shows no signal when streaming fails. If you select **Last Frame**, the screen will show the last frame when streaming fails.

Step 5 Set the sub-stream switch. Check the checkbox of **Enable Auto-Switch** to enable auto-switch of sub-stream.

Step 6 Select the **LED Window Display Mode**. Normal and Tiled are selectable.

Step 7 Click **OK** to save the settings.

## 5.2.4 Configuring Virtual Screen

### **Purpose:**

Video wall layout is restricted by the physical screen and in practice, one physical screen usually displays more than one signal source. Virtual screen layout allows one physical screen to display multiple signal sources and get rid of the restriction of physical screen.

Step 1 On the Video Wall interface, click  and select **Modify Video Wall** to enter the Modify Video Wall interface.

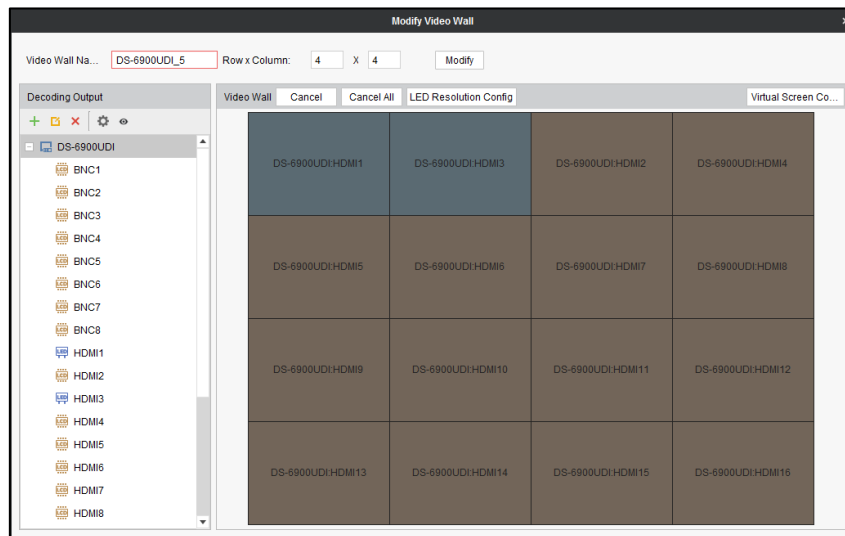

Figure 5-19 Modify Video Wall

Step 2 Select the output area for adding virtual screen.

Step 3 Click **Virtual Screen Config** to expand the **Virtual Screen Configuration** menu.

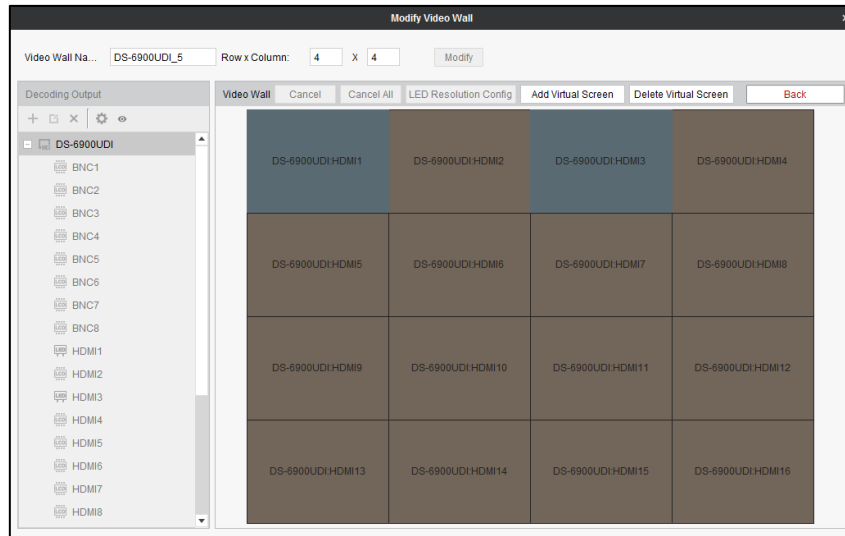

Figure 5-20 Configure Virtual Screen

Step 4 Select the window(s) you want to add virtual screen.



**NOTE**

You cannot add virtual screen across the LCD and LED areas.

Step 5 Click **Add Virtual Screen** to enter **Configure Virtual Screen** interface.

1. Select a virtual screen mode from and input the row and column number.



**NOTE**

For the mode, the row number ranges from 1 to 16 and column number ranges from 1 to 20. For modes such as , the row number ranges from 2 to 16 and the column number ranges from 2 to 20. For modes such as , the row number ranges from 2 to 16 and the column number ranges from 3 to 20.

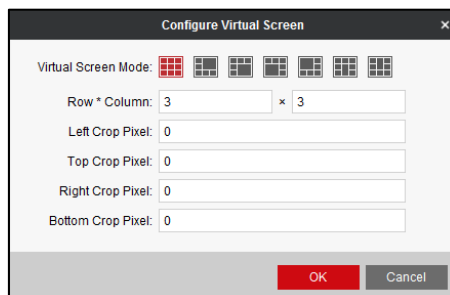

Figure 5-21 Configure Virtual Screen

2. Input the **Left Crop Pixel**, **Top Crop Pixel**, **Right Crop Pixel** and **Bottom Crop Pixel** in the corresponding text fields.



3. Click **OK** to save the settings and the dotted line in grey constitutes the virtual screen division.

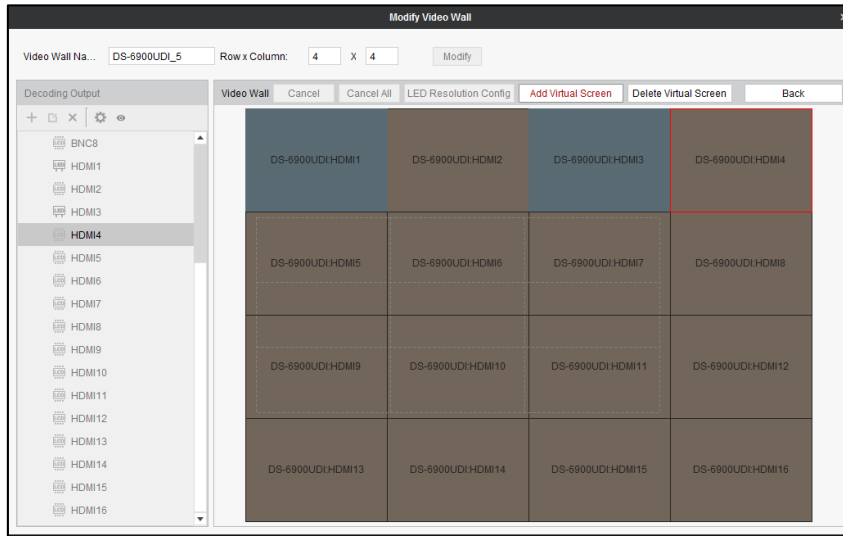

Figure 5-22 Added Virtual Screen

Step 6 (Optional) Select the configured virtual screen area and click **Delete Virtual Screen** to delete it.

Step 7 On the Video Wall interface, drag a signal source to the window, and you can view the live view in the virtual video wall layout.

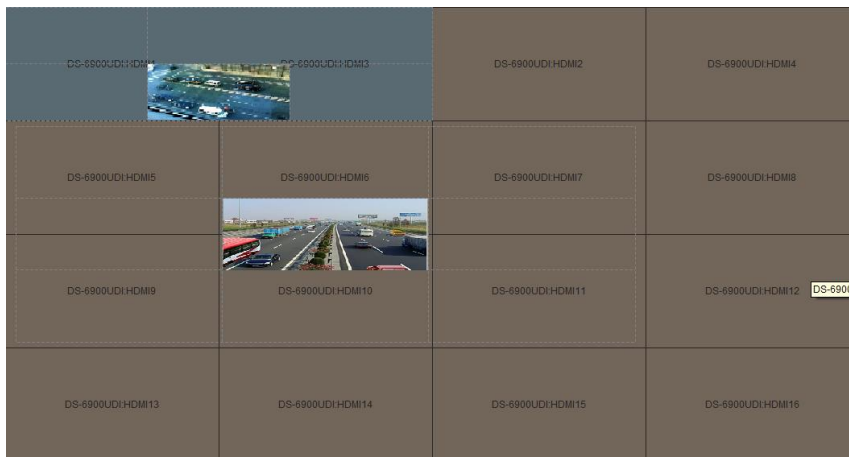

Figure 5-23 Live View in Virtual Screen

## 5.3 Displaying Video on Video Wall

### **Purpose**

After the settings of the encoding device, decoding device and video wall, the video stream from the encoding devices can be decoded and displayed on the video wall.



After enabling decoding and displaying, the video from the encoding devices can be displayed on the video wall. And the real-time live view is shown on the physical video wall.

### 5.3.1 Decoding and Displaying Video

Step 1 Enter the Video Wall interface.

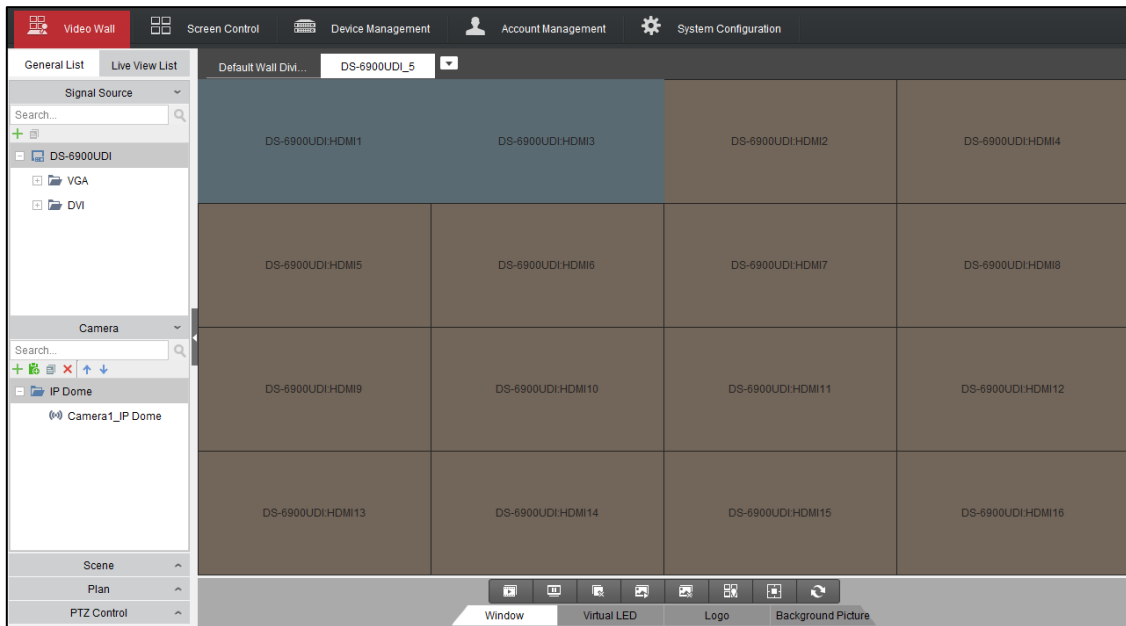

Figure 5-24 Video Wall Interface

Step 2 Click **Scene** to expand the scene interface. You can click to add a new scene, click to edit the name for the scene, click to delete the scene and click to save the scene.



Up to 8 scenes can be added.

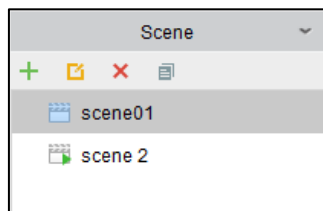



Figure 5-25 Scene List

Step 3 Drag the camera from the left side camera list to the display window of video wall. The video stream from the camera will be decoded and displayed on the video wall.

You can also select a decoding window and then double click a camera to decode and display the video. You can also hold the *Ctrl* or *Shift* key to select multiple cameras and then drag them to the video wall.

 **NOTE**

You can click  on the lower part of the interface to stop decoding of all the windows.

Step 4 If the decoded camera supports PTZ control, you can click **PTZ Control** to expand the PTZ control panel.

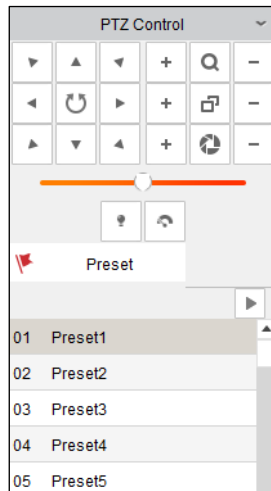

Figure 5-26 PTZ Control Panel

Step 5 Right-click on a playing window to activate the decoding management menu as shown below.

 **NOTE**

The menu differs depending on the devices.

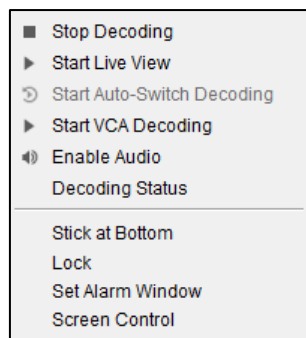

Figure 5-27 Right-click Menu

- **Start/Stop Decoding:** Start/stop the decoding.
- **Start/Stop Live View:** Start/stop the live view of the decoded video.
- **Start/Pause Auto-Switch Decoding:** Start/pause auto-switch decoding. This function is only supported by decoder.
- **Start/Stop VCA Decoding:** Start/stop VCA decoding.
- **Enable Audio:** Turn on/off the audio of the decoding video.

- **Decoding Status:** View the status of the decoding channel, like decoding status and stream type.
- **Stick at Bottom:** Generally the selected window is at top by default. Click **Stick at Bottom** to place the selected window at bottom.
- **Lock/Unlock:** Click **Lock** to lock the window. The locked decoding window is unable to do any operation.
- **Set Alarm Window:** Display the video triggered by event or alarm input on video wall.
- **Screen Control:** Enter the screen control when the RSC server is added. Please refer to Chapter 5.5 for details.

### 5.3.2 Opening Window via Coordinate

#### **Purpose**

On the LED and non-LED screen you are allowed to open the window via coordinate.

#### Opening Window for Non-LED Screen

Step 1 Enter the **Video Wall** interface, select the non-LED screen and click the button  to open the window via coordinate.

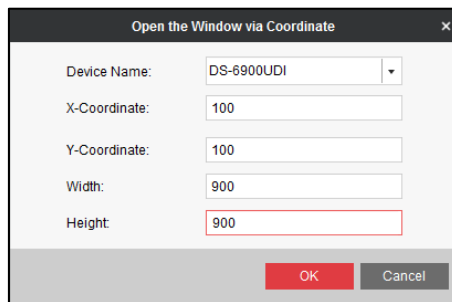

Figure 5-28 Open Window via Coordinate (1)

Step 2 Select the **Device Name** from the drop down list, and input the **X-Coordinate**, **Y-Coordinate**, **Width** and **Height**.

Step 3 Click **OK** to save the settings and the opened window will be displayed on the video wall.

#### **NOTE**

- You cannot open the window via coordinate across both the non-LED and LED screens.
- The X- coordinate and Y-coordinate are relative output channel coordinates.

#### Opening Window for LED Screen

Step 1 Enter the **Video Wall** interface, select the LED screen and click the button  to open the window via coordinate.

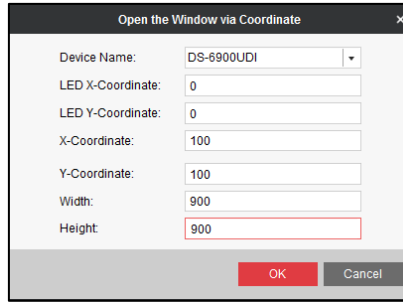

Figure 5-29 Open the Window via Coordinate (2)

Step 2 Select the **Device Name** from the drop down list, and input the **X-Coordinate**, **Y-Coordinate**, **Width** and **Height**.

Step 3 Click **OK** to save the settings and the opened window will be displayed on the video wall.

 **NOTE**

- You cannot open the window via coordinate across both the non-LED and LED screens.
- You cannot edit the LED X-Coordinate and LED Y-Coordinate.
- The X- coordinate and Y-coordinate are relative output channel coordinates.

## 5.3.3 Configuring Playback

### **Purpose**

The video file is supported to be played back on the video wall.

 **NOTE**

Playback function is only supported by decoder.

Step 1 Drag the camera on the left-side list to the display window of video wall, or you can open a window if supported.

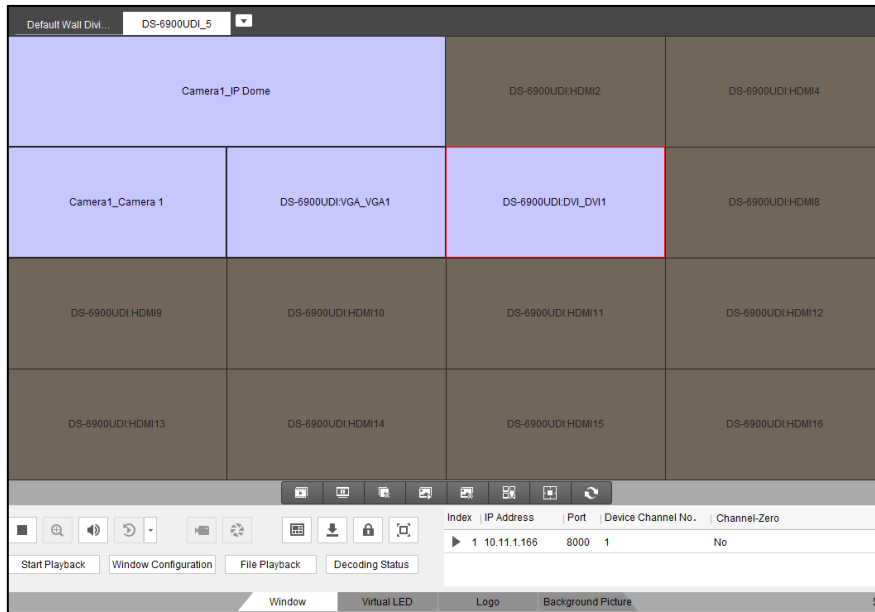

Figure 5-30 Video Wall

Step 2 Click **Window** at the bottom to unfold more configuration and operation toolbar.

Step 3 Click **Start Playback** to start searching the video files of the camera.

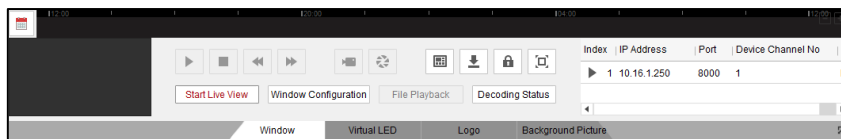



Figure 5-31 Playback Interface

Step 4 If the record file is of current day, the video file can be played back automatically. If not, you can click  to show the date and click **More Search Conditions** to specify more conditions, and click **Search** to find the video file.

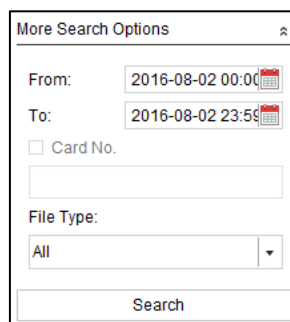







Figure 5-32 Search Record File

The following icons are available for controlling the playback.

Table 5-2 Playback Toolbar



Icon	Function
	Pause/Start the playback
	Delete View
	Slow Forward
	Fast Forward
	Start/Stop Clipping
	Capture

### 5.3.4 Configuring Auto-Switch Decoding

**Purpose**

Auto-switch decoding refers to you can configure multiple video streams in a video output and the dwell time in switching video streams.

Step 1 Drag a camera group to the display window of the video wall.

Step 2 Click  to set the dwell time for the auto-switch decoding and click  to start auto-switch decoding. You can view the auto-switch decoding on the physical video wall. You can click  to stop auto-switch decoding.

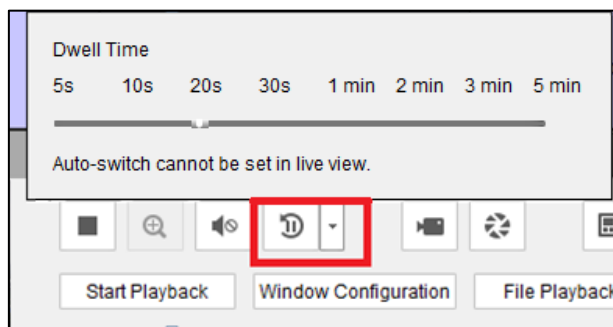

Figure 5-33 Auto-Switch Decoding

### 5.3.5 Window Configuration

**Purpose:**

You can set the window as the alarm window to display the video triggered by event or alarm input on the video wall. You can also set the decoding delay and image parameters.

Step 1 Drag the camera from the left-side list to the display window of the video wall, or you can open a window if supported.

Step 2 Click **Window Configuration** to pop up the configuration dialog box.

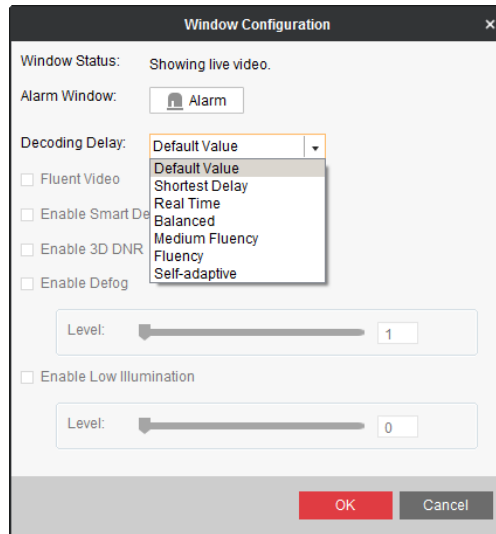

Figure 5-34 Window Configuration

Step 3 Configure the parameters as needed. The window status shows the current status of the selected window.

- **Alarm Window:** Display the video triggered by the event or alarm input on the selected window of the video wall.
- **Decoding Delay:** Set the delay status of the decoding according to the actual needs.



NOTE

Functions like Fluent Video, Smart Decoding, 3D DNR, Defog, and Low Illumination are not supported by DS-6900UDI.

## 5.4 Decoding Thermal Network Camera

### **Purpose**

The thermal network camera can be connected to the decoder and you can realize live view and playback, and decode the video including the temperature or fire point information on the video wall.

### 5.4.1 Configuring the Thermal Network Camera Parameters

#### **Purpose**

You can configure the corresponding parameters of thermal network camera via the Web browser first before decoding it on the video wall.

#### Configuring Temperature Measurement

Step 1 Configure the VCA resource type.



1. Log in to the camera via the Web browser.
2. Click **Configuration > Advanced Configuration > System > VCA Resource Type** to enter the VCA Resource Type configuration interface.
3. Select **Temperature Measurement and Behavior Analysis** as the VCA Resource Type.
4. Click **Save** to save the settings.

Step 2 Configure temperature measurement.

1. Click **Configuration > Advanced Configuration > Temperature Measurement > Temperature Measurement Configuration** to enter the Temperature Measurement configuration interface.

Figure 5-35 Temperature Measurement Configuration

2. Check the checkboxes of the interface to set the temperature measurement configurations.
  - **Enable Temperature Measurement:** Check the checkbox to enable temperature measurement function.
  - **Display Temperature Info. on Stream:** Check the checkbox to display temperature information in live view.
  - **Add Original Data on Capture:** Check the checkbox to add original data on capture.
  - **Add Original Data on Stream:** Check the checkbox to add original data on stream.
3. Select the **Data Refresh Interval** from 1s to 5s.
4. Select the **Unit** to display temperature with Degree Celsius (°C)/Degree Fahrenheit (°F)/Degree Kelvin (K).
5. Configure the **Temperature Range**.
6. Click **Save** to save the settings.

Step 3 Configure the temperature measurement and alarm.

1. Click **Configuration > Advanced Configuration > Temperature Measurement > Temperature Measurement and Alarm** to enter the Temperature Measurement and Alarm configuration interface.

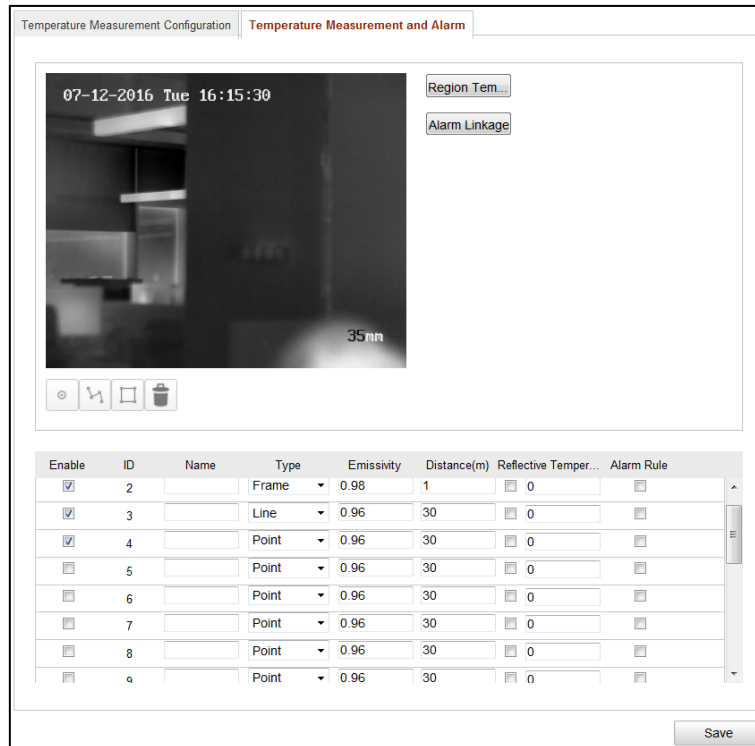



Figure 5-36 Temperature Measurement and Alarm

2. Set the alarm rule: Select a temperature measurement rule from the rule list and configure the parameters.

- **Name:** You can customize the rule name.
- **Type:** Select point, line, or frame as rule type.
- **Emissivity:** Set the emissivity of your target. The emissivity of each object is different.
- **Distance (m):** The straight-line distance between the target and the device.
- **Reflective Temperature:** If there is any target with high emissivity in the scene, check the checkbox and set the reflective temperature to correct the temperature. If no such target exists, uncheck the checkbox.

3. Click  in the list to show the alarm rule interface.

- **Alarm Rule:** The alarm rule varies according to different types. The rule is to compare the temperature information of two selected regions. For targets set by frame, the rules include: **Max. Temperature is Higher than**, **Max. Temperature is Lower than**, **Min. Temperature is Higher than**, **Min. Temperature is Lower than**, **Average Temperature is Higher than**, **Average Temperature is Lower than**, **Temperature Difference is Higher than**, and **Temperature Difference is Lower than**. For targets set by line, the rules include **Max. Temperature**, **Min. Temperature**, and **Average Temperature**. For targets set by point, the rules are distinguished by **Average Temperature**.
- **Pre-Alarm Temperature and Alarm Temperature:** Set the pre-alarm temperature and alarm temperature. The device sends pre-alarm when its rule temperature exceeds pre-alarm temperature and sends alarm when its rule temperature exceeds alarm temperature.



- **Tolerance Temperature:** Set the tolerance temperature and the device judges whether the triggered alarm stops until the device temperature/temperature difference is lower than rule temperature by tolerance temperature. For example, set tolerance temperature as 3°C, set alarm temperature as 55°C, and set pre-alarm temperature as 50°C. The device sends pre-alarm when its temperature reaches 50°C and it alarms when its temperature reaches 55°C and only when the device temperature is lower than 52°C will the alarm be cancelled.
4. Draw the Target Region. Select the rule and draw the corresponding frame/line/point.  
Click  to draw the point. Click  to draw the line. Click  to draw the frame.



Figure 5-37 Draw Point



Figure 5-38 Draw Line



Figure 5-39 Draw Frame

5. Set Temperature Difference Alarm. Click **Temperature Difference Alarm** to enter the temperature difference alarm interface, up to four temperature difference alarms can be set.



Temperature Difference Alarm is only applicable to the targets set by frame.

6. Set Alarm Linkage. Click **Alarm Linkage** to enter the alarm linkage interface and set the linkage methods.
7. Click **Save** to save the settings.

Step 4 Configure the local parameters to display the temperature information on the live view interface.

1. Click **Configuration > Local Configuration** to enter the Local Configuration interface.

The screenshot shows the 'Local Configuration' interface with the following settings:

- Live View Parameters:**
  - Protocol:  TCP,  UDP,  MULTICAST,  HTTP
  - Live View Performance:  Shortest Delay,  Auto
  - Rules:  Enable,  Disable
  - Image Format:  JPEG,  BMP
  - Display Temperature Info.:  Enable,  Disable
  - Display Temperature Info. on Capture:  Enable,  Disable
- Record File Settings:**
  - Record File Size:  256M,  512M,  1G
  - Save record files to: C:\Users\yanjamin\Web\RecordFiles (Browse)
  - Save downloaded files to: C:\Users\yanjamin\Web\DownloadFiles (Browse)
- Picture and Clip Settings:**
  - Save snapshots in live view to: C:\Users\yanjamin\Web\CaptureFiles (Browse)
  - Save snapshots when playback to: C:\Users\yanjamin\Web\PlaybackPics (Browse)
  - Save clips to: C:\Users\yanjamin\Web\PlaybackFiles (Browse)

A 'Save' button is located at the bottom right of the interface.

Figure 5-40 Local Configuration

2. In the Live View Parameters section, select the **Enable** radio button of **Display Temperature Info. on Stream** to display the temperature information on the live view interface.
3. Click **Save** to save the settings and then you can view the position of the configured point, line and frame, the ID and temperature information on the live view interface.

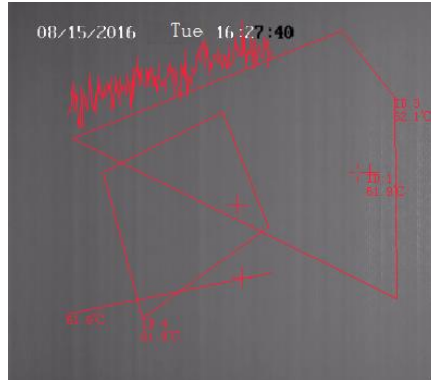

Figure 5-41 Live View

## Configuring Dynamic Fire Source Detection

Step 1 Configure the VCA resource type.

1. Log in to the camera via the Web browser.
2. Click **Configuration > Advanced Configuration > System > VCA Resource Type** to enter the VCA Resource Type configuration interface.
3. Select **Dynamic Fire Source Detection** as the VCA Resource Type.
4. Click **Save** to save the settings and the device will reboot to take the settings into effect.



For the VCA resource type, only one type can be configured. For example, if you select **Temperature Measurement and Behavior Analysis** as the VCA resource type, you cannot set **Dynamic Fire Source Detection**.

Step 2 Configure dynamic fire source detection parameters.

1. Click **Configuration > Advanced Configuration > Smart Event > Dynamic Fire Source Detection** to enter the Dynamic Fire Source Detection configuration interface.

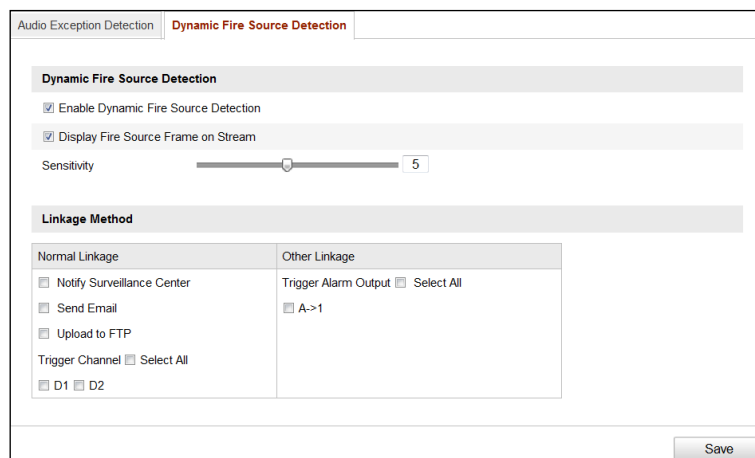

Figure 5-42 Dynamic Fire Source Detection

2. Check the checkbox of **Enable Dynamic Fire Source Detection** to enable the function.
3. (Optional) Check the checkbox of **Display Fire Source Frame on Stream** to display a red frame around the fire source on stream when fire occurs.
4. You can slide the cursor to adjust the **Sensitivity** degree of dynamic fire source detection from 1 to 10. The bigger the number is, the more sensitive the detecting would be.
5. Check the checkbox to select the **Linkage Method** taken for the alarm input.
6. Click **Save** to save the settings.

Step 3 Configure the local parameters to display fire point distance, display highest temperature, locate highest temperature point or frame fire point on the live view interface.

1. Click **Configuration > Local Configuration** to enter the Local Configuration interface.

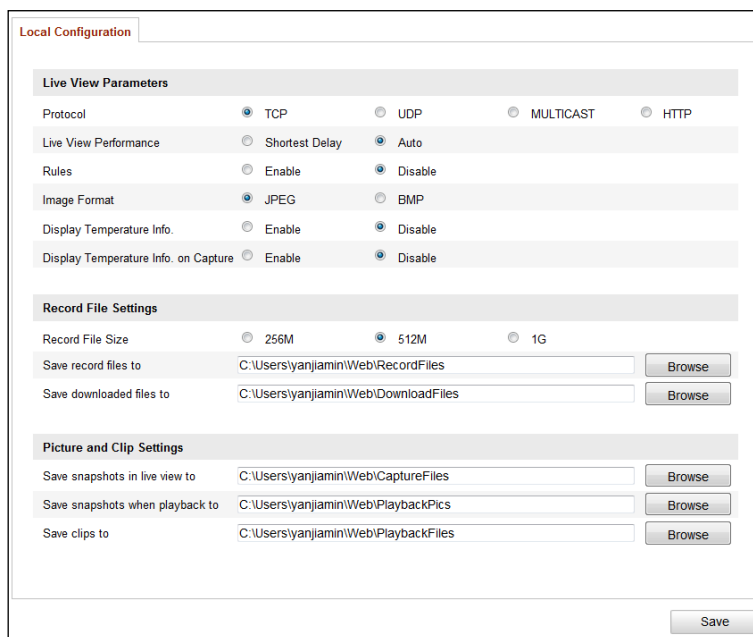

Figure 5-43 Local Configuration

2. In the Live View Parameters section, check the checkbox after **Fire Point** to enable the functions required. **Display Fire Point Distance**, **Display Highest Temperature**, **Locate Highest Temperature Point** and **Frame Fire Point** are selectable.
3. Click **Save** to save the settings and then you can view the fire point distance, highest temperature, highest temperature point or fire point frame in the live view if fire point is detected.

## Configuring Ship Detection

Step 1 Enter **Configuration > Advanced Configuration > System > VCA Resource Type** to select **Ship Detection** as the VCA Resource Type.

Step 2 Click **Configuration > Advanced Configuration > Smart Event > Ship Detection** to enter the Ship Detection interface.

Step 3 Check the checkbox of **Enable Ship Detection** to enable the function.

Step 4 Check the checkbox of **Display Detection Frame on Video** to display the frame and alarm line on stream.

Step 5 Input the device height in the textbox as the height of device above the water level.

Step 6 Draw the ship detection area and the alarm lines.

1. Click **Draw Area** button. Click the mouse on the live view image to draw a ship detection area and right-click to finish drawing. The alarm will be uploaded when ship is detected in this area.
2. Click **Draw Alarm Line** button. Click the mouse on the live view image to draw an alarm line and right-click to finish drawing. The device alarms and counts the ship number when ships are detected in the area and the ship information will be displayed on the right.



**NOTE**

Make sure the alarm line is longer than the width of ship detection area.

3. Click **Recount** to start counting the ships detected in the area afterwards.

Step 7 Check the checkbox to select the linkage method taken for the alarm input.

Step 8 Click **Save** to save the settings.

## Configuring VCA

Step 1 Configure the live view parameters to enable rules.

1. Click **Configuration > Local Configuration** to enter the Local Configuration interface.

The screenshot shows the 'Local Configuration' interface with the following settings:

- Live View Parameters:**
  - Protocol:  TCP,  UDP,  MULTICAST,  HTTP
  - Live View Performance:  Shortest Delay,  Auto
  - Rules:  Enable,  Disable
  - Image Format:  JPEG,  BMP
  - Display Temperature Info:  Enable,  Disable
  - Display Temperature Info. on Capture:  Enable,  Disable
- Record File Settings:**
  - Record File Size:  256M,  512M,  1G
  - Save record files to: C:\Users\yanjamin\Web\RecordFiles (Browse)
  - Save downloaded files to: C:\Users\yanjamin\Web\DownloadFiles (Browse)
- Picture and Clip Settings:**
  - Save snapshots in live view to: C:\Users\yanjamin\Web\CaptureFiles (Browse)
  - Save snapshots when playback to: C:\Users\yanjamin\Web\PlaybackPics (Browse)
  - Save clips to: C:\Users\yanjamin\Web\PlaybackFiles (Browse)

A 'Save' button is located at the bottom right of the configuration panel.

Figure 5-44 Local Configuration

2. On the **Live View Parameters** section, select the **Enable** radio button after **Rules** to display the colored marks when the motion detection, face detection, or intrusion detection is triggered. E.g., enabled as the rules are, and the face detection is enabled as well, when a face is detected, it will be marked with a green rectangle on the live view.

Step 2 Configure the VCA information.

1. Click **Configuration > VCA Configuration > VCA Info.** to enter the VCA Information interface.

Figure 5-45 VCA Information

2. On the **Display Information** section, check the checkboxes to enable corresponding displays.
  - **Display Target info. on Alarm Picture:** There will be a frame on the target on the uploaded alarm picture if the checkbox is checked.
  - **Display Rule info. on Alarm Picture:** The captured target and the configured area will be framed on the alarm picture.
  - **Display VCA info. on Stream:** The green frames will be displayed on the target if in a live view or playback.

Step 3 Configure the rules for VCA. Refer to the User Manual of Thermal Network Camera for the specific operations.

## 5.4.2 Decoding Thermal Network Camera on the Video Wall

Step 1 Add the thermal network camera to the video wall client software.

Step 2 On the Video Wall interface, drag the added thermal network camera to the video wall.

Step 3 Click  to start live view and you can view the corresponding information on the live view interface.



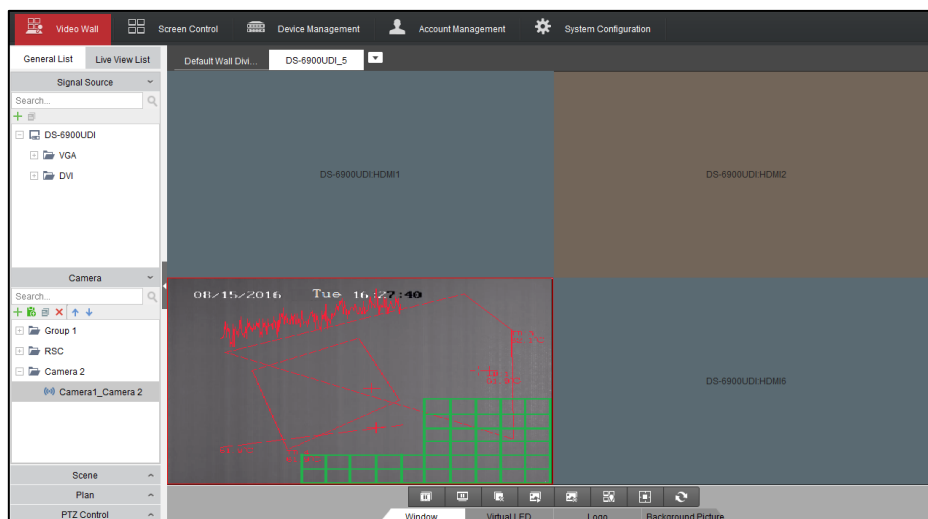



Figure 5-46 Decode Thermal Camera on the Video Wall

## NOTE

- If VCA is enabled for the thermal network camera, the decoder can analyze the VCA behavior, mark the moving target and track it. You can view the VCA information marked in the green frames in the live view. If the rule configured for the thermal network camera is broken, the alarm will be triggered.
- If temperature measurement is enabled, you can view the position of the configured point, line and frame, the ID, and temperature information in the live view.
- If fire point detection is enabled and there is a fire point detected, you can view the configured fire point distance, highest temperature, highest temperature point and fire point frame in the live view.
- If ship detection is enabled and there is a ship detected, you can view the configured frames and alarm line in the live view.

Step 4 (Optional) You can click **Window** tab on the bottom of the interface and click **Start Playback** to start playing back the camera. Refer to *Chapter 5.3.3 Configuring Playback* for reference. The temperature measurement, fire source detection, ship detection and VCA information can be played back.

Step 5 (Optional) You can click  or click **Stop VCA Decoding** from the right-click menu to stop VCA decoding of the thermal network camera.

## 5.5 Remote Screen Control

### **Purpose**

Installed with the RSC Server, it allows you to show your PC screen on the video wall. Follow the following procedure to configure the RSC server and get your screen shown on the video wall.

## 5.5.1 Configuring the RSC Server

Step 1 Install the RSE Server, which enables the PC screen to be displayed on the video wall, and

double-click  to run it.

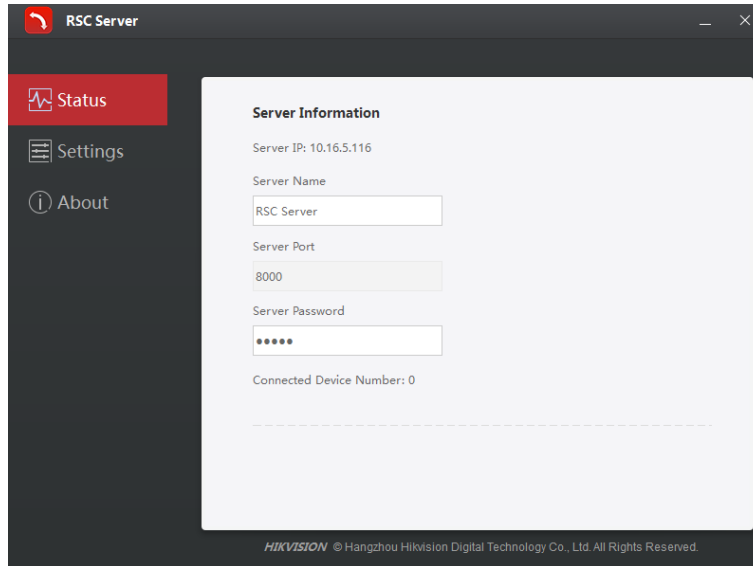

Figure 5-47 Run the RSC Server

Step 2 You can click **Status** to check the server information, including the IP address, name, port, password of the server, and the connected device number.

Step 3 Click **Settings** to check the directory of saving the program files, enable or disable the feature of Auto-Run when OS starts, and select the language (Chinese/English).

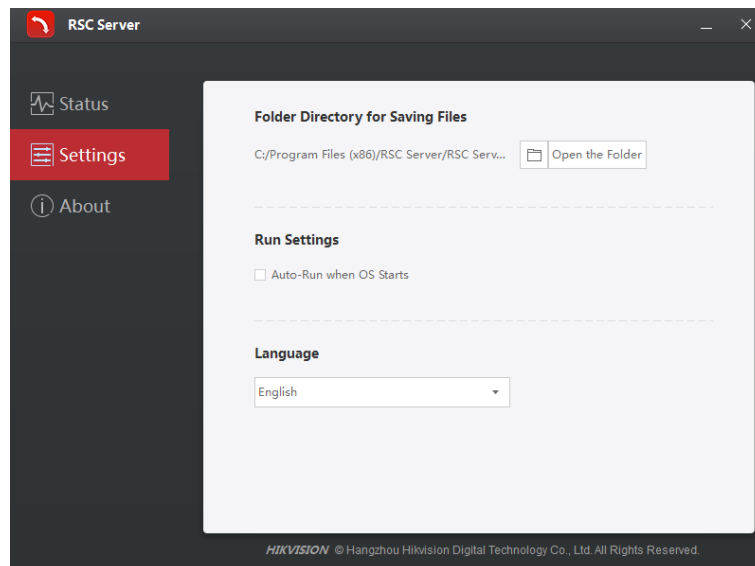

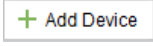

Figure 5-48 Local Configuration of RSC Server

## 5.5.2 Remote Screen Control via RSC Server

Step 1 Enter the Video Wall interface and click  in the Camera list area, or click  on Device Management interface to add the RSC server.

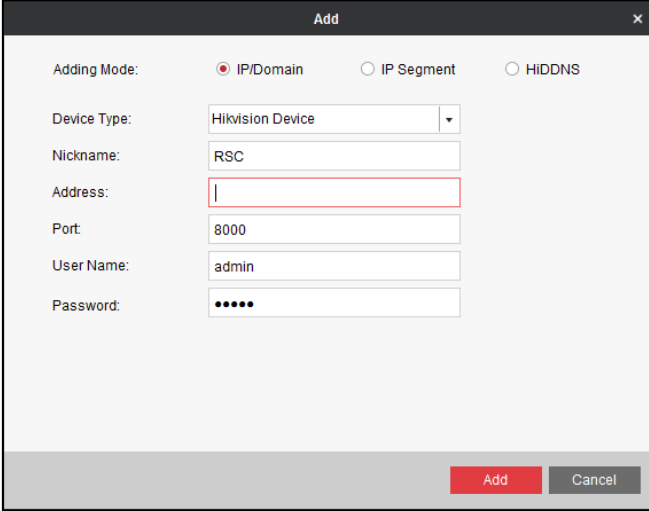

Figure 5-49 Add RSC Server

Enter the parameters to add the RSC server. Please refer to Chapter 0

Step 2 Adding an Encoding/Decoding Device to add the RSC server.



**NOTE**

The default user name is *admin* and the server password is 12345 and we highly recommend you to change the default password to avoid the security problem.

Step 3 The successfully added RSC server is listed in the camera list.

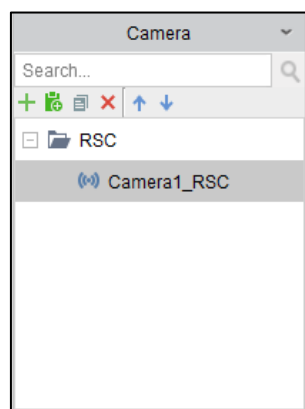

Figure 5-50 Added RSC Server

Step 4 On the camera list, drag the RSC server to the video output window.

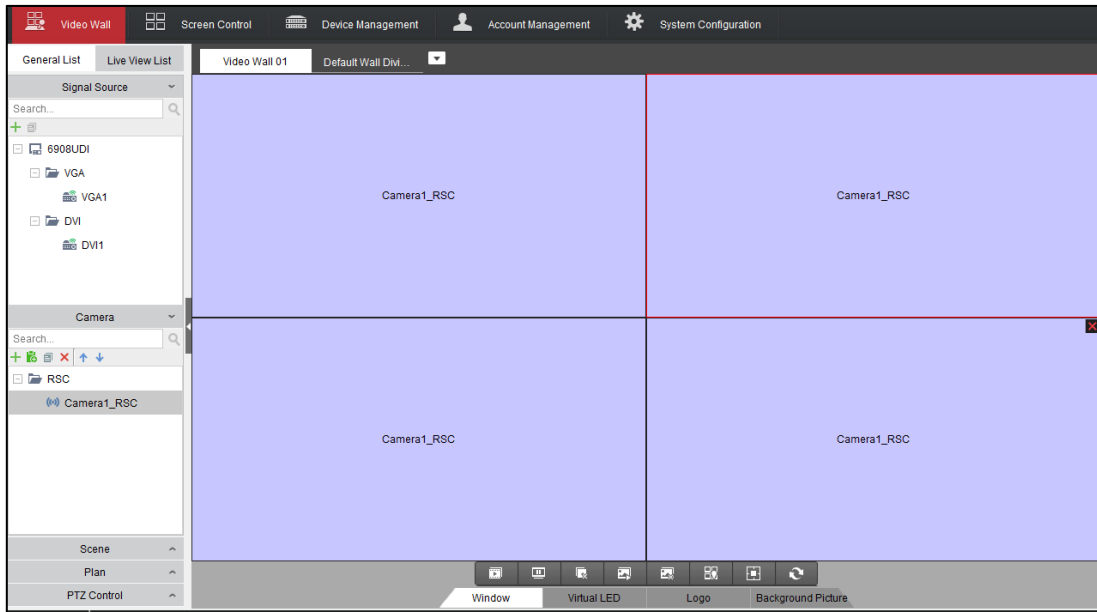

Figure 5-51 Link RSC to Video Wall

Step 5 Right click on the window and select **Screen Control** to remotely control the signal source.



The RSC server supports the screen control for 1-channel video output only.

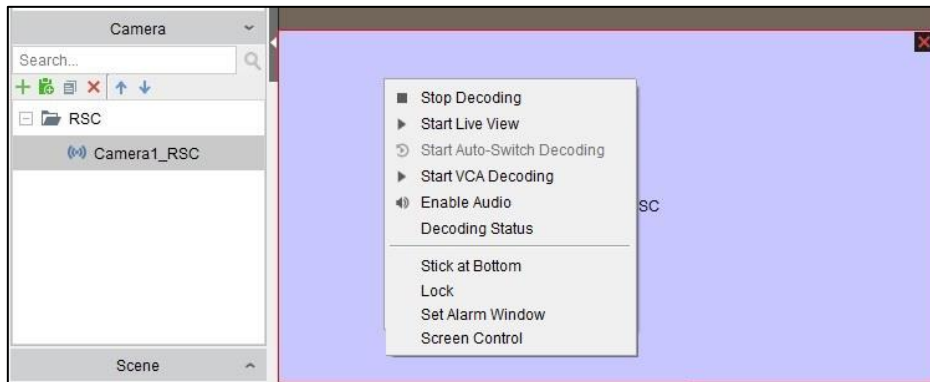

Figure 5-52 Right-click Menu

Step 6 You can use the toolbar on the window's upper right corner to realize the operations for image, video, PPT and remark.

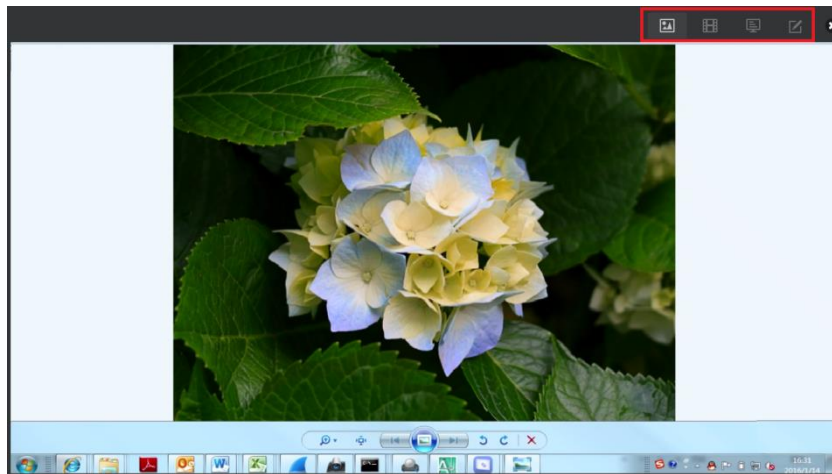

Figure 5-53 Screen Control Interface

- Click  to display all the image files in the directory set in the RSC Sever.

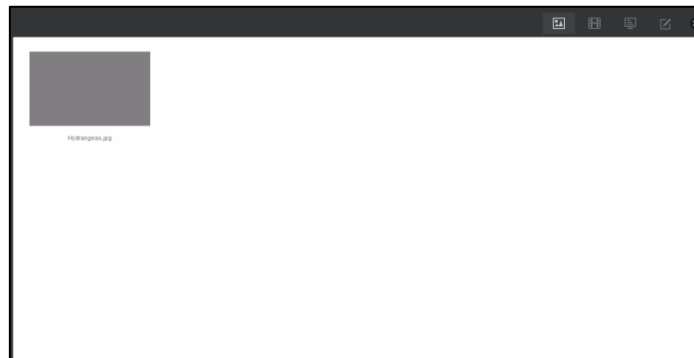

Figure 5-54 Screen Control Interface (1)

- Click  to display all the video files in the directory set in the RSC Sever.

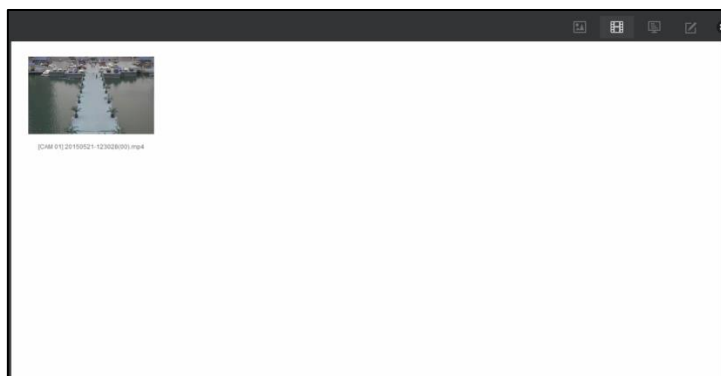



Figure 5-55 Screen Control Interface (2)

- Click  to display all the PPT files in the directory set in the RSC Sever.

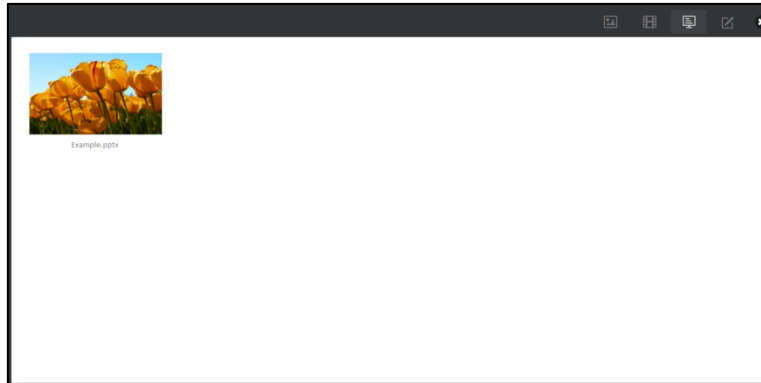

Figure 5-56 Screen Control Interface (3)

- Click  to pop up the following remark tool bar. You can select a color and set the line width to make remarks on the PPT.



Figure 5-57 Remark Tool Bar

## 5.6 Remote Configuration

### **Purpose**

On the Remote Configuration interface, you can configure the parameters of the added device, including the system, network, event, etc..

- Step 1 On the Device Management interface, click to select an added device from the list and click **Remote Configuration** to enter Remote Configuration interface.

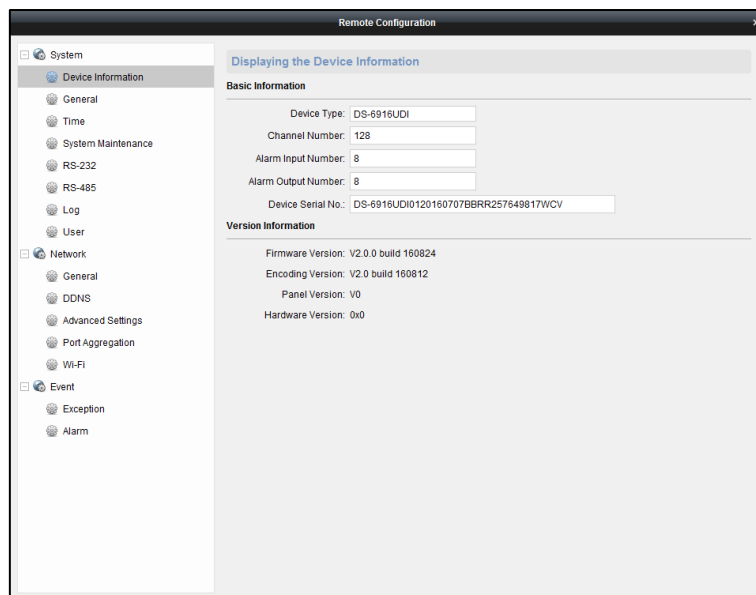

Figure 5-58 Remote Configuration

Step 2 Configure the System parameters, Network parameters and Event parameters on the Remote Configuration interface.

## 5.6.1 Configuring Port Aggregation

### **Purpose**

The Port Aggregation (Ethernet Channel) is port link aggregation technology or port-channel architecture used for the connection between the switches.

Step 1 Click **Remote Configuration > Network > Port Aggregation** to enter the Port Aggregation Settings interface.

Step 2 Select a link number from the list.

Step 3 Check the checkbox to select the network interfaces to form a channel-group link, which can effectively enhance the link transmission bandwidth.

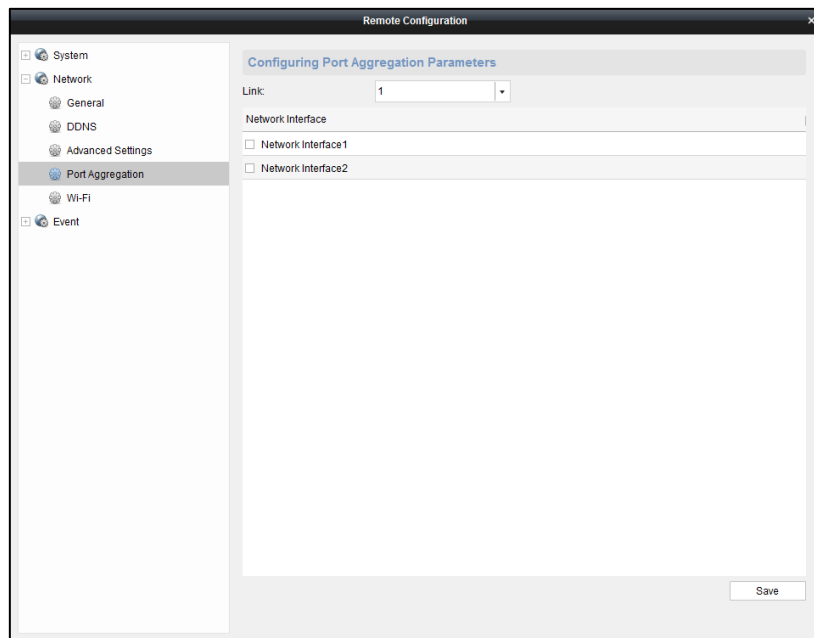

Figure 5-59 Port Aggregation Settings

 **NOTE**

- The port aggregation is not supported by DS-6901UDI.
- The switch connected to DS-6900UDI must be configured with the port aggregation as well.
- Two adjacent network interfaces cannot be selected to form a link. For example, you can select Network Interface 1 and Network Interface 3, or Network Interface 2 and Network Interface 4.
- The network interface 1 corresponds to the GE1 interface, network interface 2 to G1, network interface 3 to GE2, and network interface 3 to G2 on the rear panel.
- The G1 and G2 can be used as 2G switch when the network interface 2 and network interface 4 are configured in port aggregation.

## 5.6.2 Configuring Wi-Fi Settings

### *Purpose*

The Wi-Fi can be used as the supplement of the wired network. You can get stream and decode the video on the video wall when Wi-Fi is enabled if no wired network can be accessed.

### *Before you start*

The Wi-Fi is disabled by default. You must enable DHCP first on the WLAN Settings interface.

Step 1 On the Remote Configuration interface, click **Network > Wi-Fi** and click **Configuring the Wi-Fi Settings** tab to enter the Wi-Fi Settings interface.

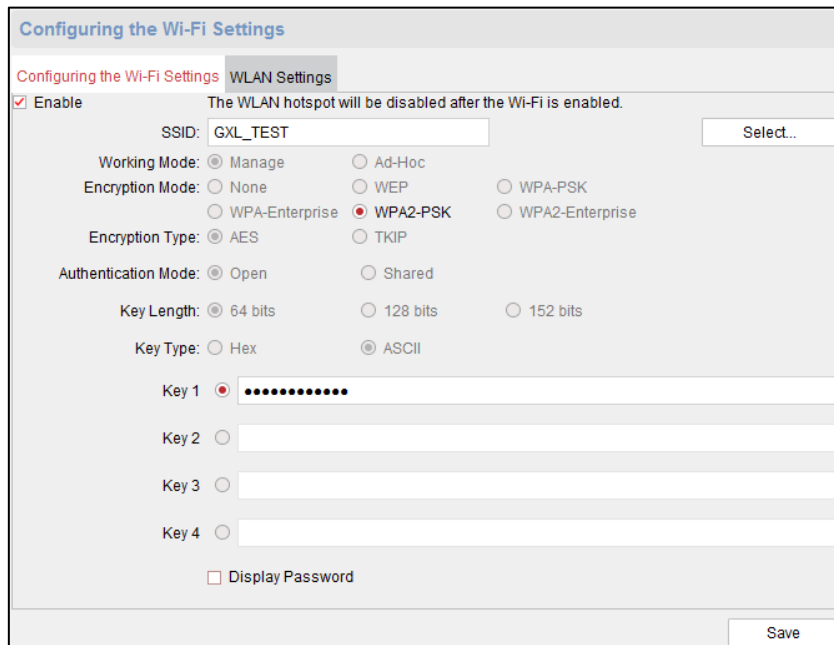

Figure 5-60 Wi-Fi Settings



Step 2 Check the checkbox of **Enable** to enable Wi-Fi.

Step 3 Input an effective **SSID**.

Step 4 Click **WLAN Settings** tab to enter the WLAN Settings interface.

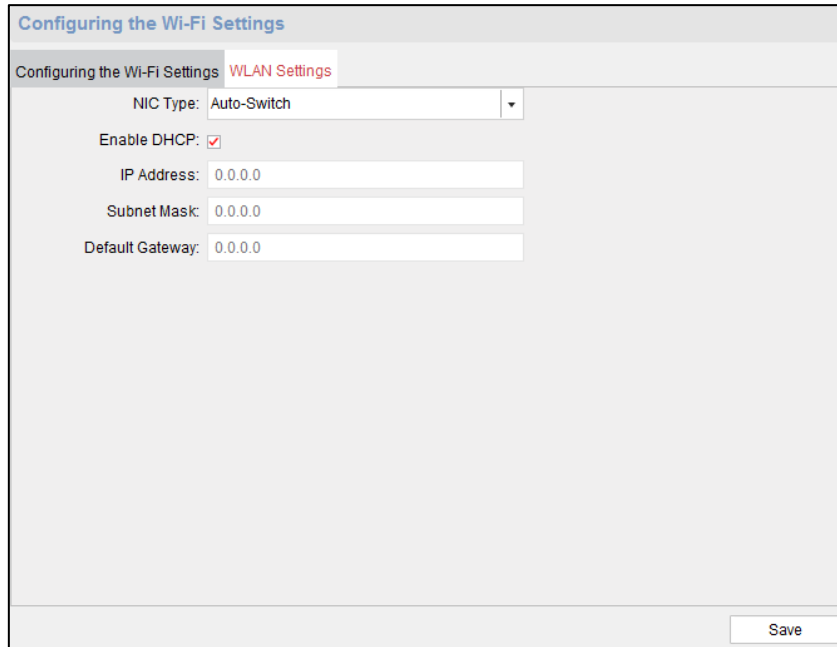

Figure 5-61 WLAN Settings

Step 5 Select the **NIC Type** to **Auto-Switch** and check the checkbox of **Enable DHCP**. Click **Save** to save the settings and the device will reboot to enter the Wi-Fi mode.

**NOTE**

If you want to enable Wi-Fi, you must select NIC Type to Auto-Switch. In this mode, if wired network cable is connected, wired network will be connected by priority. If wired network cable is not connected, the configured Wi-Fi will be connected.

Step 6 After the device reboots, enter the remote Wi-Fi settings interface. Click Select.. to select a Wi-Fi from the list and click **Save** to enable the selected Wi-Fi.

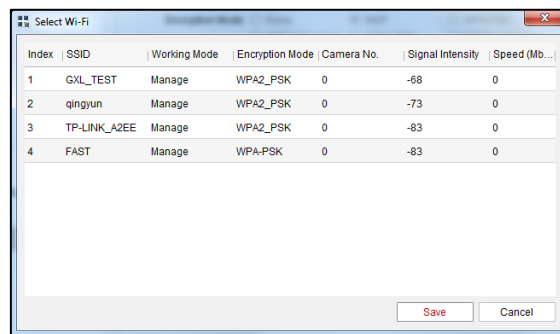

Figure 5-62 Select Wi-Fi

Step 7 Select one **Key** for activation. 4 keys can be selected. Input the key and you can check the checkbox of **Display Password** to show the clear-text password.

 **NOTE**

8 to 63 ASCII characters or 8 to 64 hexadecimal characters are allowed.

Step 8 Click **Save** on the Wi-Fi Settings interface to save the settings.

 **NOTE**

- If wired network cable is connected to the device when the Wi-Fi is enabled, wired network will be connected by priority. But the decoding capability will conform to the configuration in the Wi-Fi mode.
- In Wi-Fi mode, up to 16 channels can be decoded with up to 1080p resolution of each channel and the maximum bandwidth is 64 Mbps.

## Chapter 6 Display via Wi-Fi Connection

### Purpose

With the Wi-Fi module connected, the DS-6900UDI supports displaying the signal from mobile phone or pad via AirPlay (IOS) or DLNA (Android) to the video wall or other display units.

Step 1 Insert the Wi-Fi module to the DVI video input connector on the rear panel of the device.

Step 2 Use your phone or pad to search and connect the Wi-Fi network (default ID: DIRECT-TV-DONGLE-XXXXXX, default password: 12345678 )

Step 3 Open the browser of your phone or pad and input *https://192.168.211.161* in the address field to enter the settings page.



Figure 6-1 Settings Page

Step 4 Configure the HDMI Dongle parameters, including the Name, Hotspot Password, Device Display Output and the Soft-Ap Frequency.

### NOTE

The Soft-Ap Frequency parameter must be consistent to the phone or pad performance.

Step 5 Turn on the AirPlay (IOS) or DLNA (Android) to start playing the signal from the phone to the connected display unit. Please refer to the user manual of your phone for the details of AirPlay or DLNA instructions.

# Chapter 7 Appendix

## 7.1 Specifications

Table 7-1 DS-6901/6904/6908 UDI Specification

Model		DS-6901UDI	DS-6904UDI	DS-6908UDI
Video/Audio output	VGA and DVI-I input	/	WSXGA: 1680×1050@60Hz WXGA: 1440×900@60Hz WXGA:1280×800@60Hz, 1366×768@60Hz, 1080p: 1920 × 1080@50/60Hz UXGA: 1600 × 1200@60Hz XVGA: 1280 × 960@60Hz 720p: 1280 × 720@50Hz/60Hz SXGA: 1280 × 1024@60Hz XGA: 1024 × 768@60Hz	
	Video/Audio output	HDMI output	1-ch	4-ch
VGA output		4K: 3840 × 2160@30Hz ( for even interface only) 1080p: 1920 × 1080@50/60Hz WSXGA: 1680×1050@60Hz UXGA: 1600 × 1200@60Hz (for even interface only) 720p: 1280 × 720@50Hz/60Hz SXGA: 1280 × 1024@60Hz XGA: 1024 × 768@60Hz		
		1080p: 1920 × 1080@50/60Hz WSXGA: 1680×1050@60Hz SXGA: 1280 × 1024@60Hz 720p: 1280 × 720@50Hz/60Hz XGA: 1024 × 768@60Hz		
BNC output	1-ch	2-ch, 1 DB 15	4-ch, 1 DB 15	
Audio/ Video decoding	Decoding resolution	Up to 12MP		
	Decoding channel	16-ch	32-ch	64-ch

	Decoding capability	12MP@20fps: 2-ch 8MP@30fps: 4-ch 5MP@30fps: 6-ch 3MP@30fps: 10-ch 1080p@30fps: 16-ch	12MP@20fps:4-ch 8MP@30fps: 8-ch 5MP@30fps: 12-ch 3MP@30fps: 20-ch 1080p@30fps: 32-ch	12MP@20fps:8-ch 8MP@30fps: 16-ch 5MP@30fps: 24-ch 3MP@30fps: 40-ch 1080p@30fps: 64-ch
	Split screen	1/4/6/8/9/12/16	1/4/6/8/9/12/16/25	1/4/6/8/9/12/16/25/36
External interface	Network interface	1; 10/100/1000 Mbps self-adaptive Ethernet interface	2; 10/100/1000 Mbps self-adaptive management network interface 2; 10/100/1000 Mbps self-adaptive Ethernet interface 16; 10M/100Mbps self-adaptive Ethernet interface	
	Serial interface	1 RS-232 (RJ 45), 1 RS-485		
	Two-way audio in	1-ch, 3.5 mm connector (2.0 Vp-p, 1 k Ω)		
	Two-way audio out	1-ch, 3.5 mm connector (2.0 Vp-p, 1 k Ω)		
	Audio output	1-ch	4-ch, 1 DB 15	8-ch, 1 DB 15
	Alarm in	8-ch		
	Alarm out	8-ch		
General	Power supply	12 VDC	100 to 240 VAC	
	Power consumption	≤ 15 W	≤ 70 W	
	Working temperature	-10° C to 55° C (14° F to 131° F)		
	Working humidity	10% to 90%		
	Dimensions (W × D × H)	220 × 148 × 45 mm (8.66" × 5.83" × 1.77")	440 × 311 × 44.5 mm (17.32" × 12.24" × 1.75")	
	Weight	≤ 1.2 kg (2.65 lb)	≤ 5.2 kg (11.4 lb)	

Table 7-2 DS-6910/6912/6916 UDI Specification

Model		DS-6910UDI	DS-6912UDI	DS-6916UDI
Video/ Audio output	VGA and DVI-I input	WSXGA: 1680×1050@60Hz WXGA: 1440×900@60Hz WXGA: 1280×800@60Hz, 1366×768@60Hz, 1080p: 1920 × 1080@50/60Hz UXGA: 1600 × 1200@60Hz XVGA: 1280 × 960@60Hz 720p: 1280 × 720@50Hz/60Hz SXGA: 1280 × 1024@60Hz XGA: 1024 × 768@60Hz		
	HDMI output	10-ch	12-ch	16-ch
Video/ Audio output	BNC output	5-ch, 2 DB 15	6-ch, 2 DB 15	8-ch, 2 DB 15
	Decoding resolution	Up to 12MP		
Audio/ Video decoding	Decoding channel	80-ch	96-ch	128-ch
	Decoding capability	12MP@20fps: 10-ch	12MP@20fps: 12-ch	12MP@20fps:16-ch
		8MP@30fps: 20-ch	8MP@30fps: 24-ch	8MP@30fps: 32-ch
		5MP@30fps: 30-ch	5MP@30fps: 36-ch	5MP@30fps: 48-ch
		3MP@30fps: 50-ch	3MP@30fps: 60-ch	3MP@30fps: 80-ch
1080p@30fps: 80-ch	1080p@30fps: 96-ch	1080p@30fps/3 Mbps: 128-ch		
Split screen	1/4/6/8/9/12/16/25/36			

External interface	Network interface	2; 10/100/1000 Mbps self-adaptive management network interface 2; 10/100/1000 Mbps self-adaptive Ethernet interface 16; 10M/100 Mbps self-adaptive Ethernet interface		
	Serial interface	1 RS-232 (RJ 45), 1 RS-485		
	Two-way audio in	1-ch, 3.5 mm connector (2.0 Vp-p, 1 k Ω)		
	Two-way audio out	1-ch, 3.5 mm connector (2.0 Vp-p, 1 k Ω)		
	Audio output	10-ch, 2 DB 15	12-ch, 2DB 15	16-ch, 2 DB 15
	Alarm input	8		
	Alarm out	8		
General	Power supply	100 to 240 VAC		
	Power consumption	≤ 108 W		
	Working temperature	-10° C to +55° C (+14° F to +131° F)		
	Working humidity	10% to 90%		
	Dimensions (W × D × H)	440 × 311 × 80 mm (17.32" × 12.24" × 3.15")		
	Weight	≤ 6.4 kg (14.11 lb)		

## 7.2 FAQ

- Why cannot ping the decoder?
  - Check the cable and the switch.
  - Please refer to *Chapter 3* to configure the IP address of the decoder.
- Why cannot connect the decoder with client software?
  - Check the decoder IP address.
  - Cable is connected.
  - User name and password of decoder are correct.
- Why cannot play back the record files in DVR with decoder?
  - Check the DVR network connection.
  - Check the parameters of the playback file.
  - Check if there are files existed in the selected time duration.
- Why cannot decode the stream transported by stream media server?
  - Check the network connection between decoder and stream media server.
  - Check if the stream media server port is connected with the port added on decoder.



### 7.3 List of Third-Party IP Cameras Access

IP Camera Manufacturer	Model	Supported Video Format
Panasonic	SP306H	H.265+. H.265, H.264, H.264+, MJPEG, MPEG4,
	SP336H	
Sony	SNC-CH220	
	SNC-RH124	
Axis	P5532	
	Q7404	
Sanyo	VCC-HD2500P	
SAMSUNG	SND-5080P	
Bosch	NBC265P	
Zavio	D5110	
Arecont	AC1305M	
Pelco	IX30DN-ACFZHB3	
Onvif	Supported	

0200001060914



First Choice for Security Professionals